

Ikegami

OPERATING INSTRUCTIONS & SERVICE MANUAL

9" CCTV PICTURE MONITOR

Model **PM-910A**

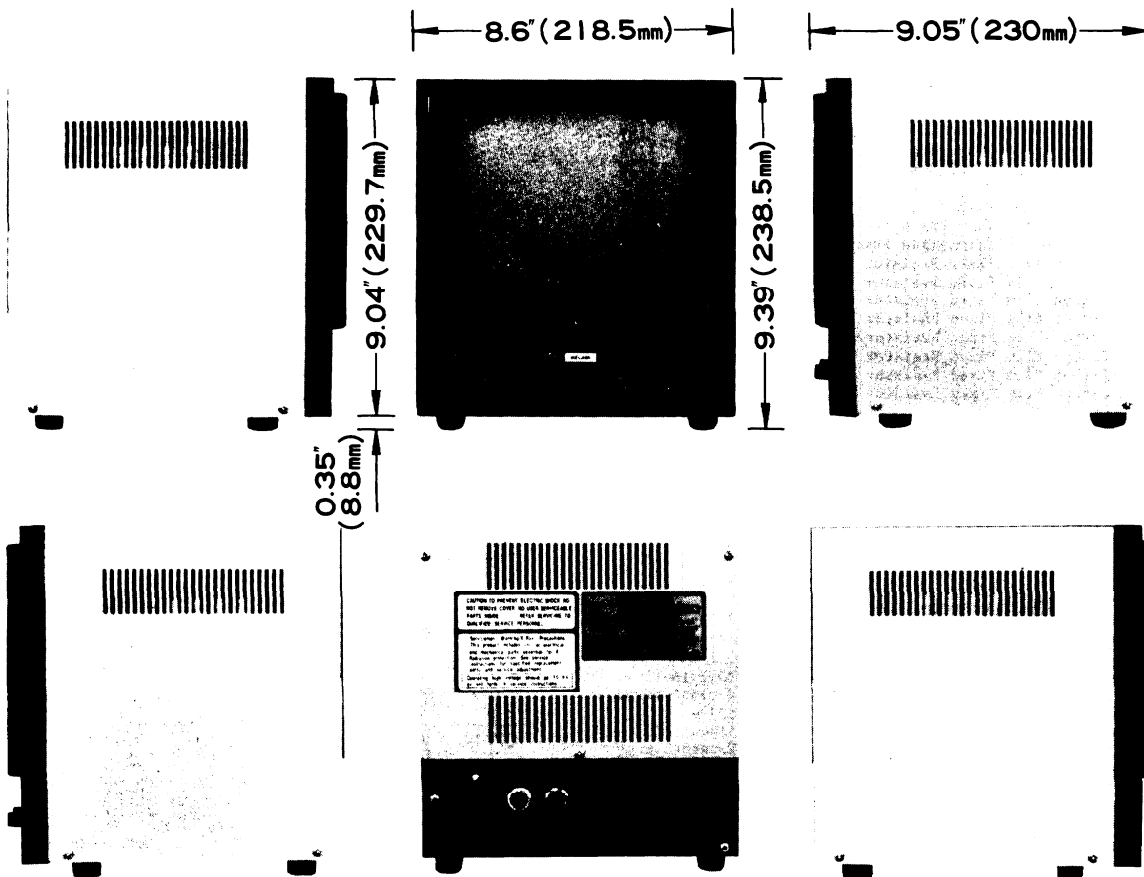
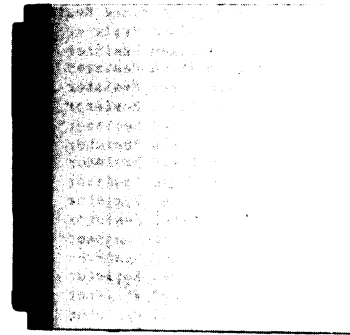

OUTDOOR USE WARNING

TO PREVENT FIRE OR ELECTRIC SHOCK, DO NOT EXPOSE THIS APPLIANCE TO RAIN OR MOISTURE.

PRELIMINARIES

PM-910A incorporates a 9" diagonal CRT. This solid state design, utilizing top quality integrated circuits and silicon semiconductors, assures an excellent picture with long term reliability. The simple circuit design and compact construction present this unit as an economical device.

This manual contains initial set up procedures, operating instructions and service informations for PM-910A.

Please note that the PM-910A picture monitor is a finely adjusted precision piece of equipment. To be assured of trouble-free operation, full performance capability and a long service life, we strongly recommend that you check these instructions completely before attempting to assemble, install or operate this monitor.

Although this picture monitor is a solid-state, modular unit using mainly low-voltage circuitry at nonhazardous energy levels, power supply voltages are present on certain parts of the interior. Such parts are not accessible in normal use, but while carrying out maintenance or repair, EXTREME CARE should be taken. Mains voltages can be LETHAL!

It is strongly recommended not to tamper with them unless really necessary, and in such cases, always follow the procedure given in these instructions. Use appropriate tools. And note that the inside adjustments or repair should only be made by a fully qualified technicians.

CARE IN HANDLING

Careful handling of the monitor and accessories should be practiced at all times, avoiding unnecessary physical shocks and similar rough handling.

The monitor should always be set up in a well-ventilated area, and shielded from any heat sources, high-powered lights, especially strong magnetic fields (such as power transformers), which may cause picture swing or distortion.

Excessive moisture-, gas- or salt-laden atmospheres should be avoided as much as possible, since circuitry components and connector contacts may be adversely affected.

Dust accumulation should be avoided, since many parts of the unit will be adversely affected in time, and the service-life will be shortened.

Regularly check the connection cables, which are prone to damage, especially in outdoor use. The cable should always be handled with care, kept free from sharp bends and kinks, and relieved from strain near the connectors. Checking of the connectors for full insertion and tightness is also recommended, especially where the same set up is used for a long time.

SAFETY INSTRUCTIONS

- * Read all of these instructions.
- * Save these instructions for later use.
- * Unplug this television monitor from the wall outlet before cleaning. Do not use liquid cleaners or aerosol cleaners. Use a damp cloth for cleaning.
- * Do not use attachments not recommended as they may cause hazards.
- * Do not use this television monitor near water—for example, near a bathtub, washbowl, kitchen sink, or laundry tub, in a wet basement, or near a swimming pool, etc.
- * Do not place this television monitor on an unstable cart, stand, or table. The television monitor may fall, causing serious injury to a child or adult, and serious damage to the appliance. Use only with a cart or stand recommended, or sold with the television monitor. Wall or shelf mounting should follow the manufacturer's instructions, and should use a mounting kit approved.

- * Slots and openings in the cabinet and the back or bottom are provided for ventilation, and to ensure reliable operation of the television monitor and to protect it from overheating, these openings must not be blocked or covered. The openings should never be blocked by placing the television monitor on a bed, sofa, rug, or other similar surface. This television monitor should never be placed near or over a radiator or heat register. This television monitor should not be placed in a built-in installation such as a bookcase unless proper ventilation is provided.
- * This television monitor should be operated only from the type of power source indicated on the marking label. If you are not sure of the type of power supplied to your home, consult your television dealer or local power company. For television monitor designed to operate from battery power, refer to this operating instructions.
- * This television monitor is equipped with a polarized alternating-current line plug (a plug having one blade wider than the other). This plug will fit into the power outlet only one way. This is a safety feature. If you are unable to insert the plug fully into the outlet, try reversing the plug. If the plug should still fail to fit, contact your electrician to replace your obsolete outlet. Do not defeat the safety purpose of the polarized plug.
- * Do not allow anything to rest on the power cord. Do not locate this television monitor where the cord will be abused by persons walking on it.
- * Follow all warnings and instructions marked on the television monitor.
- * For added protection for this television monitor during a lightning storm, or when it is left unattended and unused for long periods of time, unplug it from the wall outlet. This will prevent damaged to the receiver due to lighting and powerline surges.
- * Do not overload wall outlets and extension cords as this can result in fire or electric shock.
- * Never push objects of any kind into this television monitor through cabinet slots as they may touch dangerous voltage points or short out parts that could result in a fire or electric shock. Never spill liquid of any kind on the television monitor.
- * Do not attempt to service this television monitor yourself as opening or removing covers may expose you to dangerous voltage or other hazards. Refer all servicing to qualified service personnel.
- * Unplug this television monitor from the wall outlet and refer servicing to qualified service personnel under the following conditions.
 - a. When the power cord or plug is damaged or frayed.
 - b. If liquid has been spilled into the television monitor.
 - c. If the television monitor has been exposed to rain or water.
 - d. If the television monitor does not operate normally by following the operating instructions. Adjust only those controls that are covered by the operating instructions as improper adjustment of other controls may result in damage and will often require extensive work by a qualified technician to restore the television monitor to normal operation.
 - e. If the television monitor has been dropped or the cabinet has been damaged.
 - f. When the television receivers exhibits a distinct change in performance—this indicates a need for service.
- * When replacement parts are required, be sure the service technician has used replacement parts specified by the manufacturer that have the same characteristics as the original part. Unauthorized substitutions may result in fire, electric shock, or other hazards.
- * Upon completion of any service or repairs to this television monitor, ask the service technician to perform routine safety checks to determine that the television is in safe operating condition.

FUNCTION LOCATIONS

- ① Upper case
- ② Front escutcheon
- ③ Picture tube (CRT)
- ④ Power switch
- ⑤ Power lamp
- ⑥ V. Hold (Driver control)
- ⑦ H. Hold (Driver control)
- ⑧ Brightness
- ⑨ Contrast
- ⑩ Video input connectors (bridged)
- ⑪ Video termination switch (75-ohm ON/OFF)

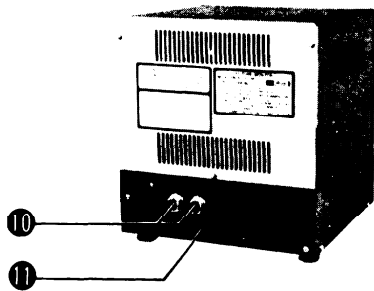
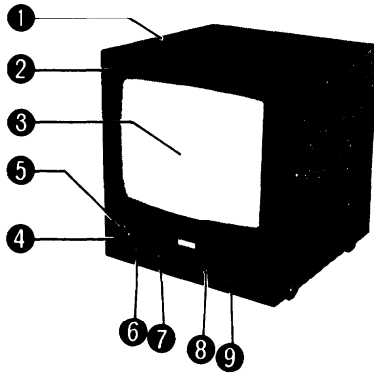

SET UP & OPERATION

Position the picture monitor in the desired location and connect the power cord to an AC outlet. And make sure that the monitor is installed securely, in a stable condition.

Make the coaxial-cable connection for video signal between the picture monitor and the signal source (video camera or VTR etc.). And make certain that all connectors are properly and fully mated, and the locking rings are securely tightened.

Set the video termination switch to 75-ohm if one monitor is to be used. (See below)

In case one camera and several monitors are to be used, switch off the 75-ohm termination switches of all monitors except the last one in the train.

If provided, set the sync internal/external switch to internal (if applicable).

After switching on the monitor and setting up the raster, adjust the brightness and contrast controls for the most pleasing picture.

BASIC CONNECTION

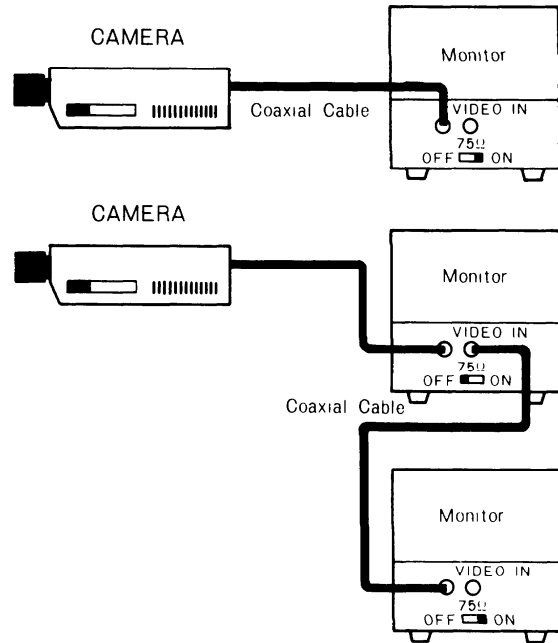

INTERNAL ADJUSTMENTS

All internal controls are factory set and locked at the optimum position. Adjustment should not be undertaken except by a qualified service technician, and only when absolutely necessary. This information is provided only as a source of reference for the qualified service technician.

There are three adjustments on the monitor main board.

HORIZONTAL FREQUENCY : This is a screwdriver adjustment to control picture horizontal position when the H. Hold cannot follow.

FOCUS : This is a screwdriver adjustment to make a correct focus when the picture is blurred.

VERTICAL HEIGHT : This is also a screwdriver adjustment to correct a height when the center circle of the test pattern is oblong vertically or horizontally.

MAINTENANCE

Although PM-910A picture monitor is designed to withstand long continuous service, it is recommended to conduct periodical inspections for longer satisfactory service with full performance.

Check the following points periodically,

- (1) The knobs and adjustments for correct positions and connections.
- (2) Connectors for good contact.
- (3) Input and output circuits for short-circuit.
- (4) Internal temperature drift.
- (5) Soldering portions.

And keep the monitor interior clean as much as possible.

PARTS LIST

- * MARKED VALUES ARE SUBJECT TO CHANGE WITHOUT NOTICE
- * MARKED PARTS ARE CRITICAL COMPONENT OF X-RAY RADIATION

Components identified by the Δ symbol have special characteristics for safety.

These critical safety components are designed to "fail safe" under abnormal conditions. The failure of any one component often causes stress in other components which could lead to smoke or fire or other hazards. Because of this, components are selected and tested under actual fault conditions to ensure safe operation. Replacement with anything other than the identical Ikegami part may present a hazard.

(1) MAIN CHASSIS			
NO.	DESCRIPTION		
Δ PC101	Power Cord with Plug	SPT-2	VM0228AP
Δ SW101	Slide Switch	ESD-275	DUS
* Δ T101	Power Transformer	ST4-B27058-B4	
Δ F101	Fuse	0.25A	250V
Δ F101-a	Fuse Holder	X-N1161#01	
* Δ V101	Cathode Ray Tube	230BDB4	
* Δ DY101	Deflection York	ST4-B0350	
R101	Carbon Film Fixed Resistor	10 ohms	1/4W
C101	Polyester Film Capacitor	0.01 μ F	50WV
CN101	Connector Housing	171822-6	
CN102	Connector Housing	W-A5002-IN#02	
	Insulock Tie	BK-1	
	Insulock Tie	T-30R	
(2) P.W.B. UNIT			
NO.	DESCRIPTION		
C1	Electrolytic Capacitor	100 μ F	16WV
C2	Electrolytic Capacitor	100 μ F	16WV
C3	Ceramic Capacitor	100pF	50WV
C4	Electrolytic Capacitor	470 μ F	16WV
C5	Electrolytic Capacitor	220 μ F	10WV
C6	Ceramic Capacitor	560pF	50WV
C7	Ceramic Capacitor	1000pF	50WV
C8	Electrolytic Capacitor	10 μ F	160WV
C9	Metalized Polyester Film Capacitor	0.22 μ F	200WV
C10	Polyester Film Capacitor	0.047 μ F	100WV
C11	Electrolytic Capacitor	1 μ F	50WV
C12	Polyester Film Capacitor	0.022 μ F	50WV
C13	Electrolytic Capacitor	100 μ F	16WV
C14	Polyester Film Capacitor	0.022 μ F	50WV
C15	Polyester Film Capacitor	0.01 μ F	50WV
C16	Tantalum Capacitor	0.33 μ F	35WV
C17	Tantalum Capacitor	4.7 μ F	16WV
C18	Tantalum Capacitor	4.7 μ F	16WV
C19	Electrolytic Capacitor	10 μ F	50WV
C20	Electrolytic Capacitor	33 μ F	16WV
C21	Electrolytic Capacitor	1000 μ F	16WV
C22	Electrolytic Capacitor	220 μ F	16WV
C23	Electrolytic Capacitor	1000 μ F	16WV
C24	Electrolytic Capacitor	10 μ F	50WV
C25	Not Used		
C26	Polyester Film Capacitor	0.1 μ F	200WV
Δ C27	Electrolytic Capacitor	2200 μ F	35WV
C28	Electrolytic Capacitor	470 μ F	25WV
C29	Polyester Film Capacitor	0.01 μ F	50WV
C30	Electrolytic Capacitor	1 μ F	50WV
C31	Not Used		
C32	Ceramic Capacitor	100pF	50WV
C33	Not Used		
C34	Polyester Film Capacitor	0.022 μ F	50WV
C35	Polyester Film Capacitor	0.022 μ F	50WV
C36	Electrolytic Capacitor	4.7 μ F	50WV
C37	Polyester Film Capacitor	0.01 μ F	50WV
C38	Electrolytic Capacitor	1000 μ F	16WV
C39	Polypropylene Film Capacitor	0.0039 μ F	50WV
C40	Polyester Film Capacitor	0.001 μ F	50WV
C41	Polyester Film Capacitor	0.01 μ F	50WV
C42	Polyester Film Capacitor	0.01 μ F	50WV
* Δ C43	Polypropylene Film Capacitor	0.047 μ F	400WV
* Δ C44	Polypropylene Film Capacitor	0.047 μ F	400WV
C45	Electrolytic Capacitor	1000 μ F	16WV
C46	Electrolytic Capacitor	3.3 μ F	350WV
C47	Polypropylene Film Capacitor	0.01 μ F	630WV
C48	Electrolytic Capacitor	10 μ F	25WV BP
C49	Electrolytic Capacitor	1 μ F	50WV
C50	Polyester Film Capacitor	0.033 μ F	50WV
C51	Electrolytic Capacitor	1 μ F	50WV
C52	Electrolytic Capacitor	100 μ F	16WV
D1	LED	LN25RCP	
D2	Silicon Diode	RM-17	
D3	Silicon Diode	1S1588	
D4	Silicon Diode	RU-1A	
D5	Silicon Diode	1SS81	
D6	Silicon Diode	RU-1A	
Δ D7	Silicon Diode	S4VB10 or RB401	
D8	Silicon Diode	1SS81	
D9	Not Used		
D10	Silicon Diode	1S1588	
IC1	Integrated Circuit	AN5763	
* IC2	Integrated Circuit	AN5753	
* Δ IC3	Integrated Circuit	SI-3122P	

L1	Peaking Coil	47 μ H	
* L2	H. Width Coil	ST4-B0360	
* L3	H. Linearity Coil	ST4-B0338-C	
Q1	Silicon Transistor	2SC1815(Y)	
Q2	Silicon Transistor	2SC2441(F)	
Q3	Silicon Transistor	2SA1015(Y)	
Q4	Silicon Transistor	2SD1069 or 2SC3174	
R1	Carbon Film Fixed Resistor	75 ohms	1/4W
R2	Not Used		
R3	Carbon Film Fixed Resistor	12K ohms	1/4W
R4	Carbon Film Fixed Resistor	18K ohms	1/4W
R5	Carbon Film Fixed Resistor	1K ohms	1/4W
R6	Carbon Film Fixed Resistor	100 ohms	1/4W
R7	Carbon Film Fixed Resistor	47 ohms	1/4W
R8	Carbon Film Fixed Resistor	3.3K ohms	1/4W
R9	Carbon Film Fixed Resistor	270K ohms	1/4W
R10	Carbon Film Fixed Resistor	75 ohms	1/4W
R11	Carbon Film Fixed Resistor	82 ohms	1/4W
R12	Carbon Film Fixed Resistor	3.9K ohms	1/4W
R13	Metal Oxide Film Fixed Resistor	5.6K ohms	1W
R14	Carbon Film Fixed Resistor	390K ohms	1/4W
* R15	Carbon Film Fixed Resistor	47K ohms	1/4W
* R16	Carbon Film Fixed Resistor	56K ohms	1/4W
△ R17	Carbon Film Fixed Resistor	4.7 ohms	1/4W
R18	Carbon Film Fixed Resistor	150 ohms	1/4W
R19	Carbon Film Fixed Resistor	1K ohms	1/4W
R20	Carbon Film Fixed Resistor	680 ohms	1/4W
R21	Carbon Film Fixed Resistor	220 ohms	1/4W
R22	Carbon Film Fixed Resistor	2.2K ohms	1/4W
R23	Carbon Film Fixed Resistor	330 ohms	1/4W
R24	Carbon Film Fixed Resistor	100K ohms	1/4W
R25	Carbon Film Fixed Resistor	100 ohms	1/4W
* R26	Carbon Film Fixed Resistor	68K ohms	1/4W
* R27	Carbon Film Fixed Resistor	10K ohms	1/4W
* R28	Carbon Film Fixed Resistor	3.3K ohms	1/4W
R29	Carbon Film Fixed Resistor	6.8 ohms	1/4W
R30	Carbon Film Fixed Resistor	1 ohms	1/2W
R31	Not Used		
R32	Carbon Film Fixed Resistor	68K ohms	1/4W
△ R33	Carbon Film Fixed Resistor	4.7 ohms	1/2W
R34	Carbon Film Fixed Resistor	12K ohms	1/4W
R35	Carbon Film Fixed Resistor	100 ohms	1/4W
R36	Carbon Film Fixed Resistor	15K ohms	1/4W
R37	Metal Oxide Film Fixed Resistor	120 ohms	1W
* △ R38	Cement Filled Fixed Resistor	47 ohms	7W
R39	Carbon Film Fixed Resistor	15K ohms	1/4W
R40	Carbon Film Fixed Resistor	4.7K ohms	1/4W
R41	Carbon Film Fixed Resistor	39 ohms	1/4W
R42	Carbon Film Fixed Resistor	18K ohms	1/4W
R43	Carbon Film Fixed Resistor	3.3K ohms	1/4W
R44	Carbon Film Fixed Resistor	27K ohms	1/4W
R45	Carbon Film Fixed Resistor	220 ohms	1/4W
R46	Carbon Film Fixed Resistor	2.2K ohms	1/4W
R47	Carbon Film Fixed Resistor	68K ohms	1/4W
R48	Carbon Film Fixed Resistor	220 ohms	1/4W
R49	Carbon Film Fixed Resistor	1.5K ohms	1/4W
△ R50	Carbon Film Fixed Resistor	75 ohms	1/4W
△ R51	Carbon Film Fixed Resistor	10 ohms	1/4W
R52	Carbon Film Fixed Resistor	47 ohms	1/4W
R53	Carbon Film Fixed Resistor	1K ohms	1/2W
R54	Carbon Film Fixed Resistor	3.3K ohms	1/2W
△ R55	Metal Oxide Film Fixed Resistor	10 ohms	1W
R56	Metal Oxide Film Fixed Resistor	2.7K ohms	1W
R57	Carbon Film Fixed Resistor	1M ohms	1/4W
R58	Carbon Film Fixed Resistor	680K ohms	1/4W
R59	Carbon Film Fixed Resistor	680 ohms	1/4W
R60	Carbon Film Fixed Resistor	1.5M ohms	1/4W
R61	Carbon Film Fixed Resistor	330K ohms	1/4W
R62	Carbon Film Fixed Resistor	33K ohms	1/4W
R63	Carbon Film Fixed Resistor	47K ohms	1/2W
VR1	Variable Resistor	500 ohms	lin. taper
VR2	Variable Resistor	50K ohms	lin. taper
VR3	Variable Resistor	100K ohms	lin. taper
VR4	Variable Resistor	1K ohms	lin. taper
VR5	Variable Resistor	1K ohms	lin. taper
VR6	Variable Resistor	300K ohms	lin. taper
* T1	H. Drive Transformer	ST-603431	
* △ T2	Flyback Transformer	ST4-B0326	
TH1	Thermistor	TD5-C310	
SW1	Switch, Slide	SLP-2-1022	
CN1	Receptacle	BNC	
CN2	Receptacle	BNC	
CN3	Connector Plug	171825-6	
CN4	Connector Housing	S7-502B-59	
CN5	Connector Plug	W-P3002-#02 or W-P3502-#02	
E1	Printed Wiring Board	PWP-93-11	

RD25S 4.7 ohms J

R50A 4.7 ohms J

MPS07N 470K

RD25S 75 ohms J

RD25S 10 ohms J

RSF1B 10 ohms J

IC3	1	2	3
DC V	12.0	18.5	0.0
AC Vpp	0	1.8	0.0
WAVE FORM	—		GND

2SA 015(Y)
2SC 015(Y)



(BOTTOM VIEW)
1 Emitter
2 Collector
3 Base

2SC244(F)



(BOTTOM VIEW)
1 Emitter
2 Collector
3 Base

2SD 1069
2SD 1364



(BOTTOM VIEW)
1 Base
2 Collector
3 Emitter

SI-3122P



(BOTTOM VIEW)
1 OUT
2 IN
3 COMMON

Q4	B	C	E
DC V	—	20.0	0.0
AC Vpp	3.0	100.0	0.0
WAVE FORM			—

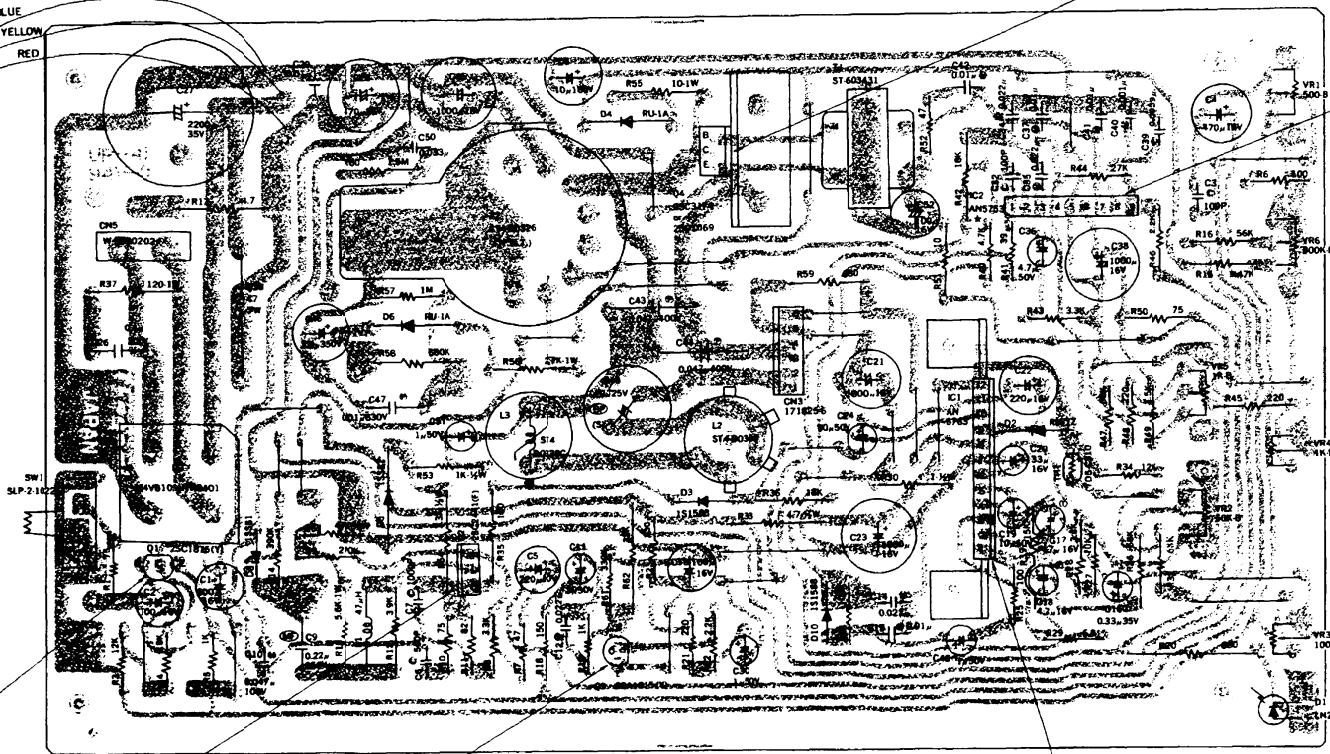
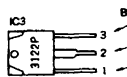

C2	DC V	AC Vpp	WAVE FORM
1	—	0.8	
2	7.2	8.4	
3	7.2	1.4	
4	2.3	0.4	
5	0	0	GND
6	10.9	0	—
7	11.3	20.0	
8	6.5	2.9	
9	2.7	0	—

Q1	B	C	E
DC V	4.6	12.0	4.0
AC Vpp	1.0	0.0	1.0
WAVE FORM		—	

Q2	B	C	E
DC V	1.3	46.0	1.0
AC Vpp	1.0	30.0	1.0
WAVE FORM			

Q3	B	C	E
DC V	11.8	0.5	12.0
AC Vpp	1.0	12.0	0.0
WAVE FORM			—

IC1	1	2	3	4	5	6	7	8	9	10	11	12
DC V	6.3	4.0	0.0	0.3	0.4	0.4	0.0	6.0	11.2	5.8	2.4	11.7
AC Vpp	2.0	1.8	0.6	0.4	0.4	0.0	0.0	22.0	10.6	2.7	10.8	0.5
WAVE FORM							—	GND				

SPECIFICATIONS

PICTURE TUBE	23cm (9") diagonal Implosion protected Type 230BLB4 or equivalent	DEFLECTION CIRCUIT SYNC STABILITY	Operation stable within input signal range of VS 0.5 ~ 2.0Vp-p
VIDEO INPUT LEVEL	VS 1.0Vp-p	RASTER DISTORTION	Less than 3%
VIDEO INPUT IMPEDANCE	75Ω or high (switchable)	DEFLECTION DISTORTION	H and V each less than 3%
VIDEO OUTPUT LEVEL	30Vp-p	BLANKING DURATION	H within 18% V within 6%
SCANNING RATES		ENVIRONMENTAL TEMPERATURE	-10°C ~ +45°C
HORIZONTAL	15.75KHz or 15.625KHz	CONNECTOR	UHF bulk connector (M type)
VERTICAL	60Hz or 50Hz	POWER REQUIREMENT	100/120V 60Hz or 220/240V 50Hz
VIDEO FREQUENCY RESPONSE	7.5MHz (+1dB, -3dB)	POWER CONSUMPTION	Less than 33VA
HORIZONTAL RESOLUTION	700 lines or better (at center)	DIMENSIONS (W.H.D.)	218.5(W) x 238.5(H) x 230(D)mm. 8.6"(W) x 9.39"(H) x 9.05"(D)
SIGNAL-TO-NOISE RATIO	55dB or better (except sync noise)	WEIGHT	5.4Kg (12 lbs) approximately
LINEARITY	4% or less (of picture height)		
STABILITY	±10% of rated voltage		
SPOT KILLER	Prevents spot burn-in of CRT with loss of power.		
ISOLATION	More than 50MΩ between AC input terminal and Cabinet		
BRIGHTNESS	More than 30FL continuously variable against rated input white signal		
VIDEO AMPLIFIER CIRCUIT			
MAXIMUM GAIN	More than 33dB		
FREQUENCY CHARACTERISTIC	Refer to 100KHz 60Hz ~ 7.5MHz: within +1, -3dB below 60MHz, over 7.5MHz: falling down characteristic		
WAVEFORM DISTORTION	Sag: less than 10% (against 60Hz square wave) Overshoot: Under 10% (against 15KHz square wave) Rise time: less than 60nS (against 250KHz square wave)		
SIGNAL-TO-NOISE RATIO	Refer to input signal, output signal is as follows: Hum noise: less than -55dB Synchronous noise: less than -35dB		

* Design and specifications are subject to change for improvement.

Ikegami

IKEGAMI ELECTRONICS (U.S.A.), INC.

HEADQUARTERS:	37 BROOK AVENUE, MAYWOOD, NEW JERSEY 07607 Phone: (201) 368-9171
WEST COAST OFFICE:	3445 KASHIWA STREET, TORRANCE, CALIF. 90505 Phone: (213) 534-0050
SOUTHWEST OFFICE:	330 NORTH BELT EAST, SUITE 228, HOUSTON, TEXAS 77060 Phone: (713) 445-0100
MIDWEST OFFICE:	31-08 RED MAPLE COURT, SOUTH BEND, INDIANA 46628 Phone: (219) 277-8240
SOUTHEAST OFFICE:	6201 JOHNS ROAD-SUITE 5 TAMPA, FL 33614 Phone: (813) 884-2046