



MODEL

HEM-1770WR

HEM-2570W

FULL HD MULTI FORMAT
OLED COLOR MONITOR

OPERATION MANUAL

Ikegami

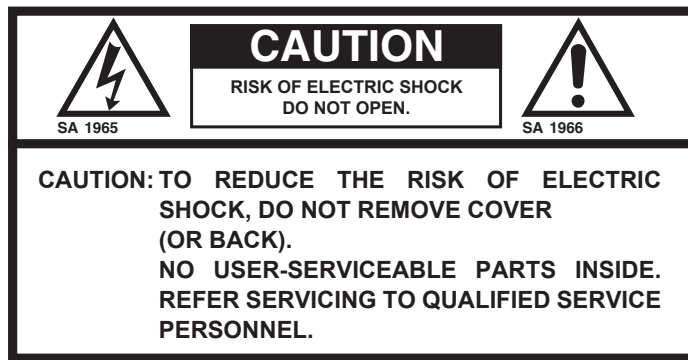

The lightning flash with arrowhead inside a triangle is intended to warn the user that parts inside the product are dangerous and many cause electric hazards.



The exclamation mark inside a triangle is intended to inform users that important operating and servicing instructions are provided with the equipment.

WARNING: FOR CONTINUED SAFETY, REPLACE SAFETY CRITICAL COMPONENTS ONLY WITH MANUFACTURE’S RECOMMENDED PARTS (REFER TO SERVICE LITERATURE).

DECLARATION of CONFORMITY:

The “CE” mark means the products as mentioned below will meet the intent of the following Directives and Standards. Inrush current according to EN55103-1 Annex B is as follows.

- HEM-1770WR :1.71A r.m.s. (the average half-cycle r.m.s. inrush current, on initial switch-on.)
:1.16A r.m.s. (the average half-cycle r.m.s. inrush current after a supply interruption of 5 s.)
- HEM-2570W :3.15A r.m.s. (the average half-cycle r.m.s. inrush current, on initial switch-on.)
:3.12A r.m.s. (the average half-cycle r.m.s. inrush current after a supply interruption of 5 s.)
- Directives** : 93/68/EEC, 2004/108/EC, 92/31/EEC for EMC (electromagnetic compatibility)
2006/95/EC for Low voltage (Safety)
- Standards** : HEM-1770WR/2570W: EN55103-1-E4, EN55103-2-E4, EN60950-1

WARNING: TO REDUCE THE RISK OF ELECTRIC SHOCK, DO NOT EXPOSE THIS EQUIPMENT TO RAIN OR WATER.



**Disposal of used Electric and Electronic Equipment
(Applicable in the European Union and other European countries with separate collection systems)**

This symbol on the product, or in the related documents in the package, indicates that this product shall not be treated as normal household waste. Instead, it should be taken to a proper applicable collection point or depot for the recycling of electric and electronic equipment.

By ensuring this product is disposed of correctly, you will help prevent possible negative consequences for the environment and human health, which could otherwise be caused by inappropriate waste handling of this product. The recycling of materials will help to conserve natural resources.

For more detailed information about recycling of this product, please contact your local city authority, your household waste disposal service or the place where you purchased the product.

NOTE:

This equipment has been tested and found to comply with the limits for a Class A digital device, pursuant to Part 15 of the FCC Rules. These limits are designed to provide reasonable protection against harmful interference when the equipment is operated in a commercial environment. This equipment generates, uses and can radiate radio frequency energy and, if not installed and used in accordance with the instruction manual, may cause harmful interference to radio communications.

Operation of this equipment in a residential area is likely to cause harmful interference in which case the user will be required to correct the interference at his own expense.

CAUTION;

ANY CHANGES OR MODIFICATIONS NOT EXPRESSLY APPROVED BY THE PART RESPONSIBLE FOR COMPLIANCE COULD VOID THE USERS AUTHORITY TO OPERATE THE EQUIPMENT.

IMPORTANT SAFETY INSTRUCTIONS

1. General

- 1) Read all instructions provided.
- 2) Save these instructions for future use.
- 3) Follow all warnings and instructions marked on the television equipment.
- 4) Never insert objects of any kind into this television monitor through cabinet slots as they may come in contact with dangerous voltage points or short out parts, resulting in fire or electric hazards, Never spill liquid of any kind on the television monitor.
- 5) Do not attempt to service this television monitor yourself as operating or removing covers may expose you to dangerous voltage or other hazards, Refer all servicing to qualified service personnel.
- 6) Do not use attachments not recommended by the television equipment manufacturer as they may result in the risk of fire, electric shock, or injury to persons.
- 7) This television monitor has been preadjusted to meet the respective broadcasting standard signals. So, it cannot be used with the signals of different broadcasting standards.
- 8) When keeping or transporting the unit for a long time, pack it in the supplied carton or equivalent.

2. Power supply

- 1) This television equipment should be operated only from the type of power source indicated on the marking label.
- 2) This television equipment is provided with a three-wire grounding type plug with a third (grounding) pin. This plug will only fit into a grounding-type power outlet. This is a safety feature. If you are unable to insert the plug into the outlet, contact your electrician to replace your obsolete outlet.
Do not defeat the safety purpose of the grounding-type plug.
- 3) When connecting and disconnecting the power cable, be sure to hold the plug.
- 4) Do not allow anything to rest on the power cord. Do not place this television equipment where the cord will be abused by persons walking on it.

- 5) For added protection for this television equipment during a lightning storm, or when it is left unattended and unused for long periods of time, unplug it from the wall outlet.
This will prevent damage to the equipment due to lightning and power-line surges.
- 6) Do not overload wall outlets and extension cords as this can result in fire or electric shock.

3. Usage and location

- 1) Do not use this television equipment near water - for example, near a bath tub, kitchen sink, or laundry tub, in a wet basement, or near a swimming pool, or the like.
- 2) Do not place this television equipment on an unstable cart, stand, or table. The television equipment may fall, causing serious injury to children and adults, and serious damage to the equipment. Use only with a cart or stand recommended by the manufacture, or sold with the television equipment. Wall or shelf mounting should follow the manufacture's instructions, and should use a mounting kit approved by the manufacture.
Television equipment and cart combination should be moved with care. Quick stops, excessive force, and uneven surfaces may cause the equipment and cart combination to overturn.



- 3) Slots and openings in the cabinet and the back or bottom are provided for ventilation, and to ensure reliable operation of the monitor and to protect it from overheating, these openings should never be blocked or covered. The openings should never be blocked by placing the television equipment on a bed, sofa, rug, or other similar surface. (This television equipment should never be placed near or over a radiator or heat register.) This television equipment monitor should not be placed in a built-in installation such as a bookcase unless proper ventilation is provided.

IMPORTANT SAFETY INSTRUCTIONS

- 4) Avoid operating or placing (keeping) in a hot (+40°C or over) or cold (less than 0°C), high vibration, or dusty place. Avoid operating or storing in a place exposed to direct sunlight.
- 5) If an image of extremely high brightness is displayed on the screen for a long time, the panel may get burned in.
- 3) Upon completion of any service or repairs to this monitor, ask the service technician to perform routine safety checks to determine that the television is in safe operating condition.
- 4) For repair service, contact **Ikegami's** authorized sales representative or **Ikegami** service desk directly.

4. Cleaning

- 1) Unplug this television equipment from the wall outlet before cleaning. Do not use liquid cleaners or aerosol cleaners. Use a damp cloth for cleaning.
- 2) Do not use thinner or benzene for cleaning. Otherwise, the cabinet may deform or the paint may peel away.

5. Repair

- 1) Unplug this television monitor from the wall outlet and refer servicing to qualified service personnel under the following conditions:
 - a. When the power cord or plug is damaged or frayed.
 - b. If liquid has been spilled into the television.
 - c. If the television monitor has been exposed to rain or water.
 - d. If the television does not operate normally by following the operating instructions.

Adjust only those controls that are covered by the operating instructions as improper adjustment of other controls may result in damage and will often require extensive work by a qualified technician to restore the television monitor to normal operation.
 - e. If the television monitor has been dropped or the cabinet has been damaged.
 - f. When the monitor exhibits a distinct change in performance - this indicates a need for service.
- 2) When replacement parts are required, be sure the service technician has used replacement parts specified by the manufacture that have the same characteristics as the original part.

Unauthorized substitutions may result in fire, electric shock, or injury to persons.

PRECAUTIONS FOR OPERATIONS

- 1) Never let this unit fall or subject it to strong shock.
- 2) Do not remove the cabinet unless necessary. High-voltage parts are contained in the cabinet and they are very dangerous if you touch them. Only qualified service engineers are allowed to adjust the internal parts of the cabinet.
- 3) This color monitor has been adjusted to signals conforming to each broadcasting standard. It cannot be used for signals of different broadcasting standards. Be sure to operate the color monitor within the voltage range marked on its back.
- 4) If cabinet or screen is dirty, wipe with soft cloth. At this time, avoid using benzene or thinner, otherwise the paint may peel away.
- 5) Note that, if video signals with high luminance are monitored on the OLED panel over a long period of time, the panel may burn in the image.
- 6) The socket-outlet shall be installed near the equipment and shall be easily accessible.
- 7) Avoid using or storing this unit in the following places:
 - Hot (+40°C or more) or cold (0°C or less) places, especially where this unit may be exposed to the direct rays of the sun.
 - Humid and dusty places.
 - Places where there is considerable vibration.
 - Places exposed to rain or water.
 - When storing or transporting this unit, pack it in the supplied carton or equivalent.
- 8) If no image can be monitored even after performing user adjustment or the unit appears faulty, do not dismantle this unit by yourself. In such cases, contact the **Ikegami** service desk.
- 9) Should this unit fail within one year after delivery, it will be repaired free of charge unless the malfunction was caused by mishandling or misuse of the user. However, the fuses are not covered by the warranty.
- 10) The specifications and appearance of this unit may be subject to change for further improvement without prior notice.

Cautions for Rack-Mount.

- A) Elevated Operating Ambient - If installed in a closed or multi-unit rack assembly, the operating ambient temperature of the rack environment may be greater than room ambient. Therefore, consideration should be given to installing the equipment in an environment compatible with the maximum ambient temperature (T_{ma}) specified by the manufacturer.
- B) Reduced Air Flow - Installation of the equipment in a rack should be such that the amount of air flow required for safe operation of the equipment is not compromised.
- C) Mechanical Loading - Mounting of the equipment in the rack should be such that a hazardous condition is not achieved due to uneven mechanical loading.
- D) Circuit Overloading - Consideration should be given to the connection of the equipment to the supply circuit and the effect that overloading of the circuits might have on overcurrent protection and supply wiring. Appropriate consideration of equipment nameplate ratings should be used when addressing this concern.
- E) Reliable Earthing - Reliable earthing of rack-mounted equipment should be maintained. Particular attention should be given to supply connections other than direct connections to the branch circuit (e.g. use of power strips).

Precautions Upon Use

In order to use the monitor safely, read through this manual and pay attention to the following points in particular.

1. Do not use any power supply other than the specified one (AC/DC).

2. Do not give a shock to the monitor.

Please be careful not to give any impact on the device because a thin glass is applied on the OLED surface.

3. Do not use or store the monitor in the following places.

Place where the ambient temperature is out of spec

When installing the monitor on a monitor shelf, switcher table, rack, etc., make sure in advance that the temperature of the installation location is within the specified range.

In the case of an outdoor setup, even if the ambient temperature is within the specified range, the inside of the monitor may be heated by direct sunlight. Therefore, keep radiation in mind. (Avoid direct sunlight.)

Never block the air outlet at the rear of the monitor and the air inlet at the side. Make sure in particular that a blackout curtain or the like does not block the air outlet.

Place exposed to rain, snow or high humidity

Use of the monitor in such a place will cause electric leakage or failure.

4. Please avoid direct sunlight on the screen.

Please avoid direct sunlight on the screen.

The screen may be deteriorated if it is exposed to direct sunlight for a long time. Please be careful when you use it outside.

5. Caution for the panel surface

The OLED panel surface is treated with a special coating to prevent the reflection. Please do not directly touch the surface as much as possible.

When you want to wipe off the dirt, first blow off the dirt on the surface, and then gently wipe it with dry soft cloth such as glass wipes dampened in water and a mild detergent.

Do not use the following solutions as they can damage the screen surface.

Prohibited solvents

Alcohol, thinner, benzine, petrol, abrasive cleaning solution, alkaline cleaning solution, acidic cleaning solution, chemical cloth, etc.

6. Do not display the same pattern for a long time.

Please do not display the fixed patterns such as marker, WFM, VECTOR, VITC, and level meter, and the fixed patterns of still pictures or videos with higher brightness. Also do not continuously operate the device under high temperature for a long time. Please note that burn-in, reduced brightness, bands, spots, etc. may be occurring due to the material properties of OLED panel.

When you are not using, please turn off the power or use "SCR OFF (SCREEN OFF)" function that is assigned to F2 switch by default and dutifully turn off the screen display. This device is equipped with a screen saver function. If the amount of the still pictures that are detected is almost same as the time set in the MENU setting, the screen display will be turned off. If this function is set to "OFF", reset the time after the operation is completed.

7. Caution for condensing.

When the monitor is used in the condition where temperature abruptly changes, the surface of outside and the inside of monitor are possible to get condensed.

And if it is used leaving condensed, it can cause deterioration of quality and trouble.

If the device is condensed, please do not turn on the power until waterdrop is disappeared completely.

8. Avoid operation or storage in a place exposed to corrosive gas.

Operation or storage in a place where any corrosive gas such as sulfur dioxide, hydrogen sulfide, chlorine or ammonia is generated may lead to a significant reduction in the monitor service life. It may also cause failure or electric leakage.

Also avoid using the monitor in a location exposed to high salty wind.

9. Do not use this monitor for such applications as space appliance, nuclear control system as any medical equipment involving human life.

10. Consideration when storing in a hard carrying case

As the monitor is delicate equipment, you must pay attention to the following points when storing the monitor in a hard case.

- If the monitor that has been stored at low temperature for a long time is suddenly exposed to high temperature environment, dew condensation may occur. When you store the monitor in the case for a long time, make sure to **store at a temperature near room temperature** and avoid the sudden temperature difference when taking out the monitor from the case.
- If you store the monitor in the case for a long time, make sure to **replace silica gels, etc. in a regular basis and store the monitor at proper humidity** as the humidity in the case can cause mold to grow.
- If the monitor is stored in the case with water droplets or condensation for a long time, the humidity stays in the case and cause mold to grow. Make sure to allow the monitor to **dry well before storing in the case.**

Quality of OLED panel

Note that because the OLED panel mounted on the monitor is manufactured through the use of high-precision technology, 99.99% or more of the pixels are effective, but 0.01% or less of them may be lacking in brightness or lit up constantly.

Integrated Fans

This monitor is equipped with two fans. The internal fan is always running whereas the fan on the back cover automatically turns on when the internal temperature increases. The latter fan may not be always running, which is due to the low temperature on the desk, etc., not due to the failure of the fan.

The fan on the back cover rotates momentarily when the power is turned on to check the operation. Depending on the operating environment, the fan may turn on when the temperature inside the monitor increases, even if the surrounding temperature is low.

Fan abnormal stop message

When the internal fan and external fan on the back are abnormally stopped, a message saying "FAN ERROR!" will be displayed.

In the case of internal fan, which is continuously operated, the message appears when the fan operation is stopped.

In the case of the fan on the back, the message appears when the fan operation is abnormal during fan operation check at the time of turning the power on, or during operation at high temperature.

If the "FAN ERROR!" is displayed, please stop the operation and contact your dealer or **TECHNO IKEGAMI Co., Ltd.**

Warranty

If the product should fail within one year from the date of delivery in spite of the proper use, the manufacturer will repair the product free of charge. Even if the product is covered by the warranty, however, the customer will be charged for labor and parts in the following cases.

1. Failure and damage caused by the following:
 - Improper use
 - Repair or modification performed by the customer
 - Transportation, transfer, falling, etc. after the purchase of the product
 - External factors such as natural disasters and over-voltage
2. OLED panel burn-in and aged deterioration (burn-in, change in brightness, increase in bright points and flashing, etc.)
3. D Scratch or dirt on the entire surface of panel, or damage, discoloration, and deterioration of the chassis
4. Replacement of the accessories and fuse

If no image comes out in spite of routine adjustment or if the product should seem to fail, contact your dealer or **Ikegami** service desk.

Standard accessories

Besides the main unit, the following accessories are mounted or attached on this monitor. Please make sure all accessories are included.

1. Operation manual: 1 copy
2. Parallel remote connector: 1 set
3. Power cable: 1 pc.
4. Tilt stand (HEM-2570W only)
5. Handle (HEM-2570W only)

* VGA, SVGA, XGA, SXGA, WXGA, UXGA and WUXGA are registered trademarks of International Business Machines Corporation.

* VESA are registered trademarks of Video Electronics Standard Association.

* Specifications and external dimensions are subject to change without prior notice.

CONTENTS

IMPORTANT SAFETY INSTRUCTIONS

PRECAUTIONS FOR OPERATIONS

Cautions for Rack-Mount.

Precautions Upon Use

For the first-time use after purchase

| | | | |
|--|----|---|----|
| 1. Outline | 1 | 5. Preset Menu Function | 56 |
| 1-1. Outline..... | 1 | 5-1 List of preset menu..... | 56 |
| 1-2. Features..... | 1 | 5-2 Description of preset menu..... | 56 |
| 2. Names of parts and their Functions | 4 | 5-2-① Selection of files..... | 56 |
| 2-1. Front Controller section..... | 4 | 5-2-② Change of preset data | 57 |
| 2-2. Rear panel (left) | 8 | 5-2-③ Display of preset data list..... | 59 |
| 2-3. Rear panel (front)..... | 9 | 5-2-④ Copying of file data | 59 |
| 2-4. Option (CM-70)..... | 10 | 5-2-⑤ Setting of file change operation | |
| 3. Markers | 11 | at the time of channel change..... | 59 |
| 3-1. Types of Markers | 11 | 5-2-⑥ Setting of data protection | |
| 4. MENU Functions | 12 | password..... | 59 |
| 4-1. List of MENU | 12 | 6. Mouse menu function | 61 |
| 4-2. Flow of MENU Operations | 15 | 6-1. Basic procedure of the mouse menu | 61 |
| 4-3. Description of MENU 1 Functions | 18 | 6-2. Basic procedures on the MENU and PRESET | |
| 4-4. Description of MENU 2 Functions | 19 | MENU screens..... | 63 |
| 4-5. Description of MENU 3 Functions | 21 | 7. Specifications | 64 |
| 4-6. Description of MENU 4 Functions | 24 | 7-1. General specifications..... | 64 |
| 4-7. Description of MENU 5 Functions | 26 | 7-2. Rated performance..... | 64 |
| 4-8. Description of MENU 6 Functions | 28 | 7-3. Specifications for OLED module..... | 66 |
| 4-9. Description of MENU 7 Functions | 33 | 7-4. Functions | 66 |
| 4-10. Description of MENU 8 | 36 | 7-5. Remote control | 67 |
| 4-11. Description of MENU 8 Functions | | 8. Applicable Standards | 68 |
| (USER MARKER) Functions and Making Settings | | 8-1. Safety standards | 68 |
| | 39 | 8-2. Electromagnetic interference..... | 68 |
| 4-12. Description of MENU 9 Functions | 43 | 8-3. Environmental regulations | 68 |
| 4-13. Description of MENU 10 Functions | 44 | 9. Mounting Bracket | 68 |
| 4-14. Description of MENU 11 Functions | 46 | 10. Options | 68 |
| 4-15. Description of MENU 12 Functions | 51 | 11. External View | 70 |
| 4-16. Description of MENU 13 Functions | 54 | (1) HEM-1770WR..... | 70 |
| 4-17. Description of MENU 14 Functions | 55 | (2) HEM-1770WR+STD-1770+GR-1770..... | 71 |
| | | (3) HEM-2570W | 72 |
| | | Data 1 PC Input Signal Compatible Format | 73 |
| | | Data 2 Parallel Remote Pin Function | 74 |
| | | Data 3 Control with Remote Controller | 75 |
| | | Data 4 Control with Remote Controller | 76 |

1. Outline

1-1. Outline

This monitor has a 17-inch/25-inch full HD OLED panel aiming to reduce the thickness, weight and power consumption, and is a HDTV/SDTV multi-format compatible OLED color monitor that is intended to be used in various spaces such as sub-control room, edit and monitor shelf, transmission control desk, and relay mobile.

By taking the functions and operability of Ikegami CRT master monitor HTM series, it achieves the functions that are required for master monitor used in professional broadcasting and provides the same operability as a conventional.

1-2. Features

(1) High performance OLED panel

The OLED panel has a full HD (1920 x 1080)/10bit panel with high brightness, high contrast, wide view angle, high speed response, and high color reproducibility, which achieves the realistic pixel display without resizing the input pixels and the gradation expression with higher fidelity.

(2) Multi-format

The monitor supports various broadcasting formats.

- 480i/59.94 (NTSC) • 1080p/24, 23.98
- 575i/50 (PAL-B) • 1035i/60, 59.94
- 480i/59.94 (*1) • 1080i/60, 59.94
- 1080psF/30 • 1080i/50
- 1080psF/25 • 720p/60, 59.94
- 1080psF/24, 23.98 • 720p/50
- 1080p/60, 59.94 • 720p/30, 29.97
- 1080p/50 • 720p/24, 23.98 (*2)
- 1080p/30, 29.97 • 720p/25
- 1080p/25

(*1) RGB/YPbPr input only

(*2) SDI input only

(3) Diverse input sources

SDI signal (3G/HD/SD) 2 input, analog composite signal 2 input, DVI-D signal 1 input (VGA/SVGA/XGA/WXGA/SXGA/UXGA/WUXGA) are included as standard.

Analog PC input and YPbPr/RGB input are also available. With the optional SFP modules (2 units) mounted, it can accommodate various inputs.

(4) Compatibility with embedded audio

It supports the embedded audio as a standard, and automatically recognizes the embedded audio signal that is multiplexed to 3G-SDI signal, HD-SDI signal, and SD-SDI (4:2:2) signal. It also enables the audio output from the built-in stereo speaker, stereo headphone, and stereo line out. (You can select which pair channels to be output on the MENU.)

The monitor also has a standard embedded audio level meter display on the screen.

(5) Remote control functions

The monitor can be remote-controlled with the use of three remote control functions. Depending on the place of installation and type of operation, the parallel, serial mode can be used.

Besides the remote control with a conventional parallel, an input interface of the serial remote controller SRC-400 (optional) that can be remote controlled by RS485 is equipped as a standard.

The SRC-400 allows you to remote control up to 96 monitors individually by connecting the monitors with loop-through using RS485. In addition, since the Ethernet connection between a controller and PC is possible, you can individually control the monitors that are connected to RS485 via SRC-400 from the PC screen. The infrared wireless remote controller RCT-30A is also set as optional.

(6) Built-in markers

4:3 (16:9 mode), 13:9, 14:9, 15:9, 16:9 (4:3 mode), 1.85:1 (16:9 mode) and 2.35:1 (16:9 mode) line markers can be displayed.

The monitor can also get the 1%-stepwise safety marker displayed in the range of 80-99% with respect to the line marker area.

The safety markers over the effective screen can be equally preset 1% by 1% in the range of 80-99%.

The monitor also comes standard abundantly with five-part split and ten-part split crosshatch markers useful for location alignment.

(7) User marker display function

Up to 100 types (10 scenes x 10 types) of user markers can be plotted. Also up to 10 types of lines or BOX markers per 1 scene can be plotted to a given positions and sizes on a pixel basis, and 10 scenes can be set.

The line and box drawing settings can be eas-

ily made with not just the switch but also the USB mouse. Resulting complicated data may also be saved on a USB memory so that the data can be copied to another monitor or stored in a PC.

This function is optimum for positioning in editing the layout and its display for various types of information such as teleshopping.

* It is patented.

(8) Shadow function

The shadow function is to shade the area other than a 4:3 (16:9 mode), 13:9, 14:9, 15:9 or 16:9 (4:3 mode) marker area on images. The shadow contrast can be set at 0%, 20%, 40% or 60% on the MENU. The use of this function allows you to instantly visualize the image area when converting images with an aspect ratio of 16:9 to those with an aspect ratio of 4:3 or vice versa.

(9) Various built-in test signals

As color bar signal, pluge signal, grayscale signal with pluge, window signal, 20% gray signal, -6.8% to 0% & 100% to 109% signals are built in as a standard inside the monitor, various adjustment tasks can be performed by the monitor itself.

(10) Time code display function

It is possible to display the time code (VITC) multiplexed into HD SDI signal on the screen.

The display comes in two sizes, large and small, and its brightness in three levels.

(11) Waveform monitor/Vector scope display functions

Waveform monitor of brightness signal can be displayed. The display comes in two sizes, NORMAL and SMALL, and its brightness in four levels. The waveform can also be displayed in any of three selectable positions and in one of two colors: GREEN and WHITE. The vector scope can also be readily displayed.

(12) Display comparison function by using 2 split screens or by switching between 2 full screens

This is a convenient function to display the still pictures that were captured in advance and the videos that are currently being input with two-screen display on the both sides of screen, and display the image that is captured on a full screen. In addition, by switching with a video or automatically switching, this function is useful to adjust and align the multiple cameras. Since up to 100 captured images can be controlled by

number on the monitor side, you can download a desired image and use it for color matching and alignments between a captured image and camera image.

(13) Dot-by-dot display function

All the picture elements of an input signal are displayed 1:1 according to the pixels of the panel without scaling the incoming signal (enlarging or reducing the input signal according to the panel pixels).

This function is useful in checking transmitted input signals for pixel defects, camera CCD's scratches, etc.

Only 1080i/p signal will be displayed at normal scan status of 1:1.

(14) External memory function

Various data (including the MENU settings, the PRESET data, and the full capture image data) can be stored on the USB memory for data management on the PC. All these data can be copied onto another monitor.

* In case the data is to be copied onto another monitor, care should be taken as the PRESET data on individual monitors are different in their data types.

The data type of the stored images is in the specific format exclusive to the device used.

(15) USB mouse control

By connecting a commercially available USB mouse to the USB terminal of this monitor, it is possible to perform various adjustments including the "MENU setting," "PRESET data setting," "Input signal switching," and the "Front switch setting" through the use of a mouse. Remote operation of the monitor at a distant position is possible by using a commercially available wireless mouse.

Use of the scroll wheel function of the mouse has significantly improved the user-friendliness of the monitor for making adjustment of various data such as color temperature.

(16) AC/DC operation (HEM-1770WR only)

The monitor can accept the AC/DC power as standard. Use of a battery is optionally possible.

The monitor allows monitoring of full HD images out of doors by use of the 17-inch type 10bit full HD OLED panel.

(17) Downmix function

Among the embedded audio 8 channels, 5.1 channel surround audio channel (Lm, Rm, C, Ls, and Rs) has been selected for the stereophonic audio function at the downmix mixing ratio specified by ARIB and ISO/IEC.

You can output the downmixed audio to the speaker that is built in the monitor, headphone, and analog output.

(18) Auto Setup Function for Color Temperature

The color temperature, which was difficult to adjust before is simply and automatically adjustable in each steps without PC, connecting this ASP-100 Auto Setup Probe to the USB port on monitors.

And it is also able to be used as the measuring instrument for measuring color temperature (color point of x, y) and contrast.

(19) 2x/4x zoom function

This function enlarges the input signal 2x and 4x without scaling, and allows you to check the scratch on the CCD of camera and fine details of the image.

(20) Image & TEST signal MIX function

While the image is displayed, "pluge signal of -2%/0%/+2%" can be displayed at the same time on the corner of the screen (small enough not to disturb the image) so that you can check if there is no "black sun" effect caused by the brightness adjustment while looking at the image.

The "brightness signal of 100 to 109%" is also displayed at the same time so that you can check if the signal of 100% to 109% is not saturated when it is input during the contrast adjustment.

(21) White balance adjustment assist function

When adjusting white balance, each switch on the front can be assigned to the direct switch for the white balance adjustment, which allows you to adjust the white balance quickly and easily.

When you remote control the white balance adjustment using a USB mouse, various adjustment buttons (BRIGHTNESS, CONTRAST, R/G/B BACKGROUND, R/G/B GAIN) are displayed on the screen with GUI. The white balance can be adjusted with ease as if you have an operation panel at hand.

(22) Interlaced display

In order to achieve a CRT-like display, it does not perform image transformation such as I/P transformation and scaling process for the 1080i

interlaced signal; however, by artificially displaying black lines between lines on the field like a CRT interlaced scanning, the CRT-like interlaced display can be achieved.

(23) CRT gamma and raster correction

It has a CRT gamma mode that is similar to the Ikegami CRT master monitor. By setting to this mode, you can operate it as the same manner as a conventional CRT master monitor.

Since the raster brightness of CRT monitor can slightly vary depending on the CRT types and color temperature adjustments, the raster brightness of CRT gamma can be arbitrary corrected according to the raster brightness of the currently used master monitor. Not only the gamma but also black can be set similar to the CRT.

2. Names of parts and their Functions

2-1. Front Controller Parts

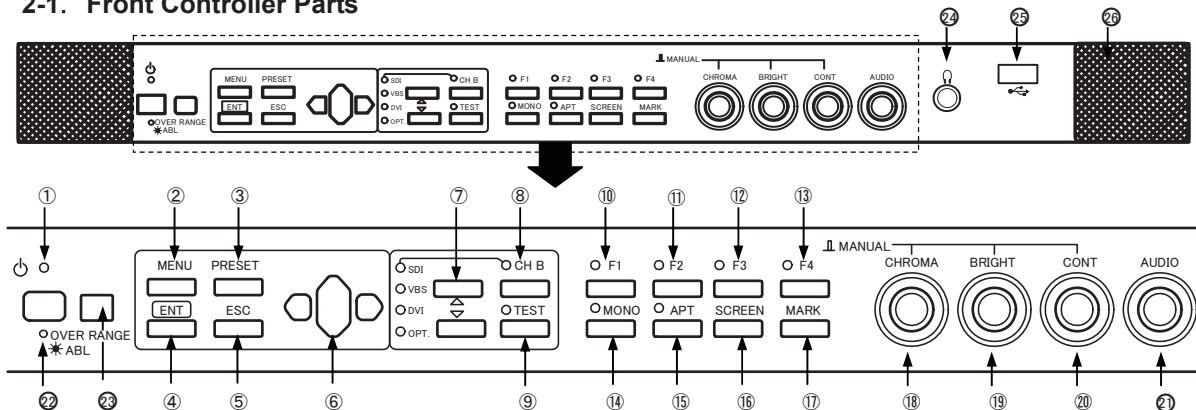

1. ■ LED operation considerations

1) LED flashing operation when the monitor is started

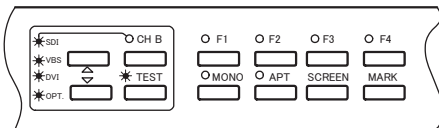

When POWER is turned on, the INPUT LEDs other than ones you selected from "⑦ to ⑨" after displaying the image will flash for approximately 1 minute. Meantime, the initialization process is executed on the panel side. Although you can operate the front switch, please wait until the LEDs stop flashing to obtain a normal image display.

2) LED flashing operation when the screen is turned off

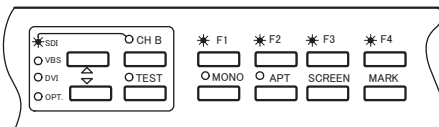

While "SCR OFF (SCREEN OFF) function" and "SCREEN SAVER function" are activated, the screen display is turned off and the selected INPUT LEDs and F1 to F4 LEDs will flash.

If you operate any switch at this time, you can cancel the screen display OFF, and the image will be displayed.

① **POWER** switch

- This switch is used to turn ON/OFF the monitor.
- * This switch will not turn ON/OFF the AC power supply for the monitor.
- * It takes several seconds for an image to come up after power-on.

POWER LED

- This LED is lit up in green when the power supply for the monitor is ON.
- Operation only for HEM-1770WR

When running on battery, this LED indicator starts flickering to tell you the remaining battery power becomes low. In such case, immediately turn off the power and replace the battery with new one. When the remaining battery power gets to the lower limit, the power is forced to shut off

and the LED indicator starts flickering at 0.5 sec. intervals after alarm is issued for 30 sec. (the LED flickering is quicken for about 30 sec.)

When using a battery, set the nominal voltage on the menu appropriately in accordance with the battery to be used.

② **MENU** switch

- This switch is pressed to display the menu screen and to change the menu screen.
- * This switch is disabled when the menu is displayed.

③ **PRESET** switch

- This switch is pressed to display the preset menu.
- * This switch is ineffective when the menu is displayed.

- ④ **ENT** switch
- Press this switch to execute menu operations.
- ⑤ **ESC** switch
- This switch is pressed to escape from menu operation.
- ⑥ **▲(UP)/▼(DOWN)/◀(LEFT)/▶(RIGHT)** switch
- Use this switch to change menu items or the setting of each item when a menu or preset menu is displayed.
 - With the menu off and the marker on, the image pattern can be preset with the **▲** and **▼** switches and the safety marker area with the **◀** and **▶** switches in the range of 80-99%
- ⑦ **INPUT SELECT** switch
- Use the **▲** and **▼** switches to change input sources.
 - * "OPT" is enabled when an optional module input is selected.
- ⑧ **CH-B** switch
- Use this switch to change channels in the SDI or VBS input mode.
- ⑨ **TEST** switch
- Press this switch to display internal test signals.
 - The switching between the following seven types of TESTS signals is done each time this switch is pressed.

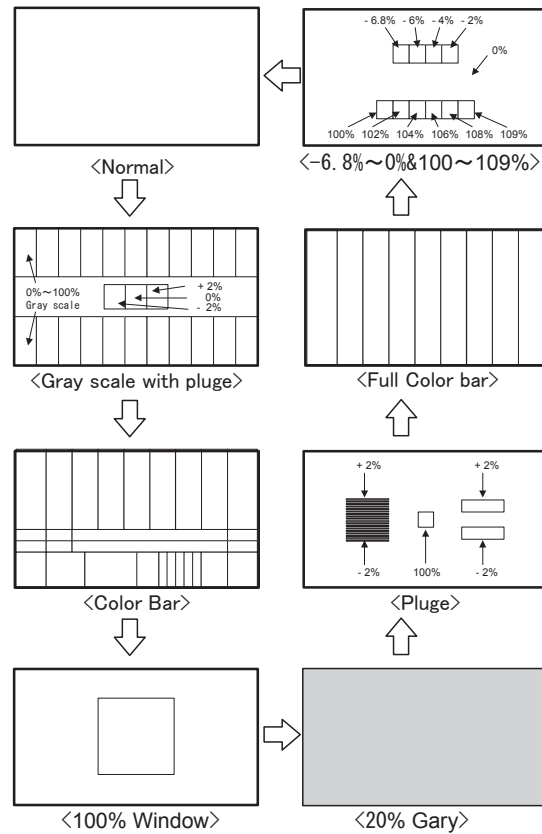

- ⑩ **F1** switch
- Press this switch to select an item preset on the menu.
 - For presettable items, refer to "4-4. Description on MENU 2 Functions"
- ⑪ **F2** switch
- Press this switch to select an item preset on the menu.
 - For presettable items, refer to "4-4. Description on MENU 2 Functions"
- ⑫ **F3** switch
- Press this switch to select an item preset on the menu.
 - For presettable items, refer to "4-4. Description on MENU 2 Functions"
- ⑬ **F4** switch
- Press this switch to select an item preset on the menu.
 - For presettable items, refer to "4-4. Description on MENU 2 Functions"
- ⑭ **MONO** switch
- This switch is pressed to make a color signal monochrome.
 - * When analog component RGB is input, this function is ineffective.

⑮ **APT** switch

- Press this switch to select the aperture.
- Set a correction amount on PRESET MENU.
- * In the PC input mode, this function is disabled.

⑯ **SCREEN** switch

- Press this switch to display images in R, G or B individually.
- The switching between colors takes place as follows each time this switch is pressed.
“R only” → “G only” → “B only” → “Normal-Screen”
- * In the PC input mode, this function is disabled.

⑰ **MARK** switch

- Press this switch to turn on/off markers.
- To change icons, use the and switches.
Detailed settings are made on MENU 8.
- * This function is disabled when an internal test signal is displayed or in the PC input mode.

⑱ **CHROMA** manual control

- This control serves as a manual/preset switch for chroma or a manual data variable control.
- The control pops out when it is pressed and the mode is changed to MANUAL.

⑲ **BRIGHT** manual control

- This control serves as a manual/preset switch for brightness or a manual data variable control.
- The control pops out when it is pressed and the mode is changed to MANUAL.

⑳ **CONT** manual control

- This control serves as a manual/preset switch for contrast or a manual data variable control.
- The control pops out when it is pressed and the mode is changed to MANUAL.

㉑ **AUDIO** control

- Use this control to adjust the sound volume of the front speaker or the headphones.
- * An audio (analog/embedded audio) to be outputted to the speaker must be set on MENU7.

㉒ **ALARM LED**

a) **ABL** indicator

- The LED flashes slowly (0.5 sec. interval) during the ABL (Auto Brightness Limiter) operation.
- ABL is a signal having a high brightness. When the contrast or brightness is increased, the current will be limited inside the panel to protect the panel and the brightness will be automatically restricted. Then, the LED flashes.
- Please reduce the contrast or brightness to use.
If both the ABL and OVER RENGÉ are operated, LED flashes quickly (approx. 0.25 sec. interval)

b) **OVER RENGÉ** indicator

- OVER RANGE increases the contrast or brightness with high brightness signal. If it exceeds the dynamic range of the signal processing circuit, the LED lights up.
- Please reduce the contrast or brightness to use.
- If both the ABL and OVER RENGÉ are operated, LED flashes quickly (approx. 0.25 sec. interval)

㉓ **Infrared receiver of wireless remote control**

- When a wireless remote controller (RCT-20A/RCT-30A) is used, point it towards this receiver.

㉔ **Stereo headphones output** (stereo mini-jack type)

- Analog audio signals, embedded audio signals and downmix audio signals are fed out of this terminal.
- The analog and embedded inputs can be selected on MENU7.
- * If you are using a sound isolating headphone, some residual sound may be heard even when the sound volume is all the way down.

㉕ **USB** terminal

- Connect a USB memory, and the monitor's data can be saved on the USB memory or the data on the USB memory can be downloaded on another monitor.
- Connect a USB mouse, and the user markers can be drawn.
- Connect the ASP-100 Rev2 to automatically adjust the color temperature.

② Stereo speakers

- Analog audio signals, embedded audio signals and downmix audio signals are fed out of this terminal.
- The analog and embedded inputs can be selected on MENU7.
- With the headphones being connected, no sound is heard from the speakers.

2-2. Rear panel (left)

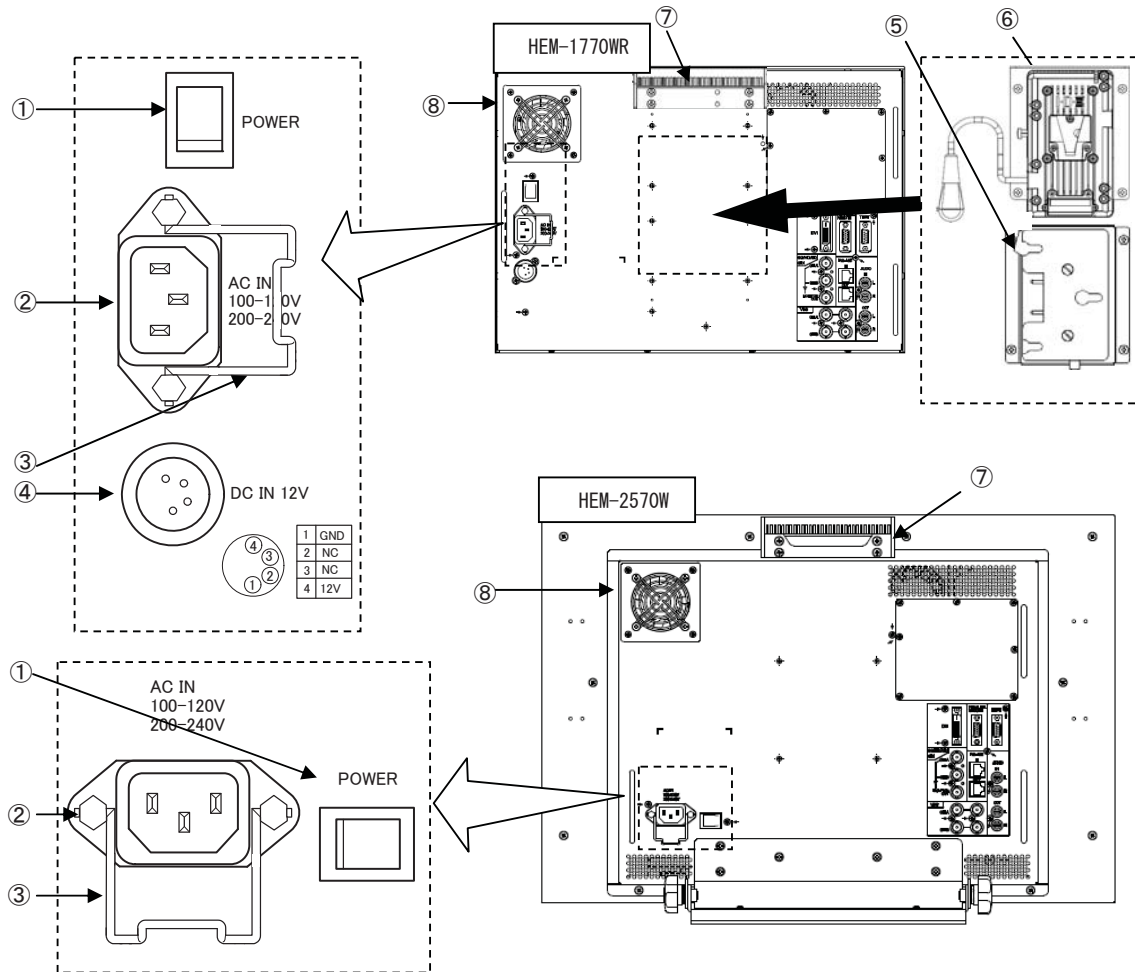

① MAIN POWER switch

- Turns on/off the AC power supply to the monitor.
- To operate the monitor, turn ON this MAIN-POWER switch as well as the POWER switch on the front panel.

② AC power input

- Insert the provided AC cable here to supply AC power.

③ Lock

- After inserting the AC plug, lock the AC plug with this lock to prevent it from disconnecting.

④ DC input

- Insert the provided DC cable here to supply DC +12V power.
- Insert the provided BB-1750A/V (option) of DC cable here to supply battery power.

⑤ BB-1750A (option)

- Insert the provided ANTON BAUER battery here to supply battery power.

⑥ BB-1750V (option)

- Insert the provided V type battery here to supply IDX battery power.

⑦ GR-1750 (HEM-1770WR is optional)

- This handle is the rubber-coated grip for easy carrying.

⑧ Fan

- This fan is easily detachable from the back.
- When power is turned on, the fan starts running for the operational check. Then, it automatically operates according to the internal temperature.
- If the fan does not start running, the message "FAN ERROR!" is displayed on the screen.

2-3. Rear panel (video inputs/outputs)

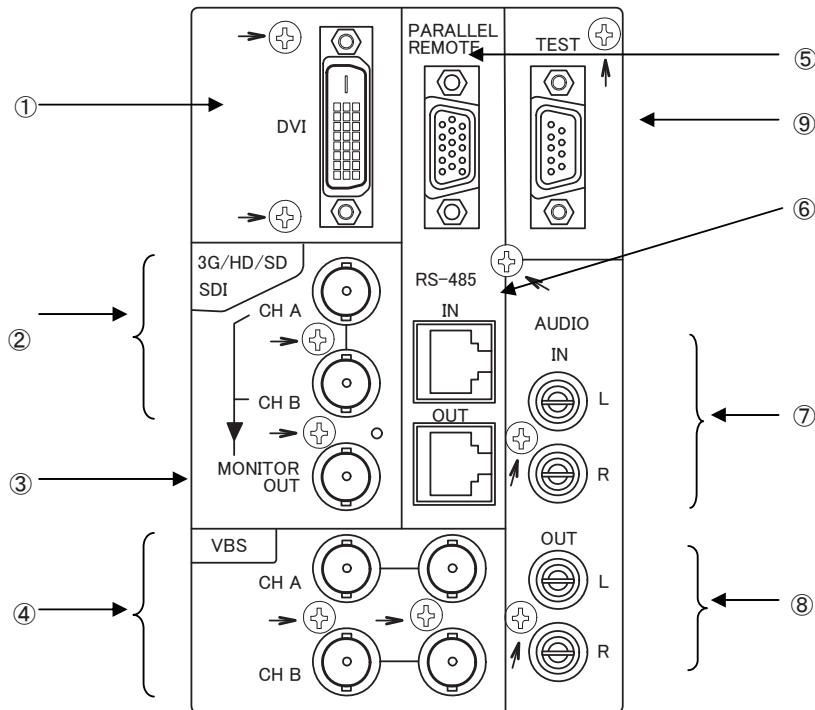

① DVI-D signal input

- This connector is used to connect the DVI-D signal from the PC.

② SDI A/B signal input

- Input the 3G/HD-SDI or SD-SDI (4:2:2) signal here.
- The format of input signal is automatically-identified.

③ SDI signal output

- Output the same selected channel signal from the A/B channel as channel select is made for monitoring.

④ NTSC/PAL-B analog composite input

- Input the NTSC/PAL-B analog composite (VBS) signal here.
- Without the loop through connection in place, connect a terminating plug.

⑤ PARALLEL REMOTE signal input

- Connect the accompanying remote connector here.

- Use a shield wire for the cable.

⑥ RS-485 input/output

- You can remote control from the optional serial remote controller "SRC-400".
- Up to 32 units can be loop-through-connected.
- Without loop-through connection, use the optional terminating device.
- * Make sure the cable used is shielded.

⑦ Analog audio input

- Feed analog audio signals here.

⑧ Analog audio output

- Outputs the analog audio signal that was set in MENU7.
- When the SDI signal is selected, the embedded audio signal is transformed to an analog audio signal.

⑨ TEST terminal for factory adjustment

- The TEST terminal is factory adjustment. Connect nothing to this terminal.

2-4. Option (CM-70 input/output)
 * Under development

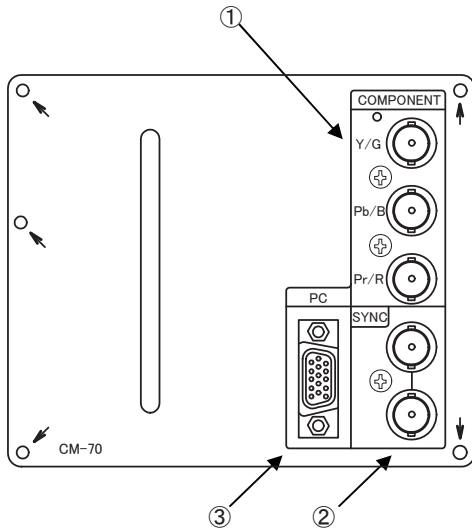

① Component (YPbPr/RGB) signal input

- Feed component signals.
- Set either YPbPr or RGB on MENU10.
- When the signal format is 1080i/60 or 1035i/60, the 1080i/1035 setting must be made on MENU10.
- To select this input, set to “OPT.” with the INPUT SELECT switches (▲ & ▼) on the front panel. Make sure that the “INPUT SELECT” on MENU10 is set at “VIDEO”. For this purpose, it is also possible to assign the function keys F1 to F4 on the front panel.

② External sync signal input

- Feed an external sync signal here when externally synchronizing component signals.
- If not adopting the loop through connection method, connect the terminating plug.
- To switch to EXT SYNC, make the setting on MENU10.
 For this purpose, it is also possible to assign the function keys F1 to F4 on the front panel.

③ Analog PC signal input

- Input the PC signal (analog RGB signal) here. As for the compatible format, refer to the "Data 1: PC Input Signal Compatible Format".
- To select this input, set to “OPT.” with the INPUT SELECT switches (▲ & ▼) on the front panel. Make sure that the “INPUT SELECT” on MENU10 is set at “PC”.
 For this purpose, it is also possible to assign the function keys F1 to F4 on the front panel.

3. Markers

3-1. Types of Markers

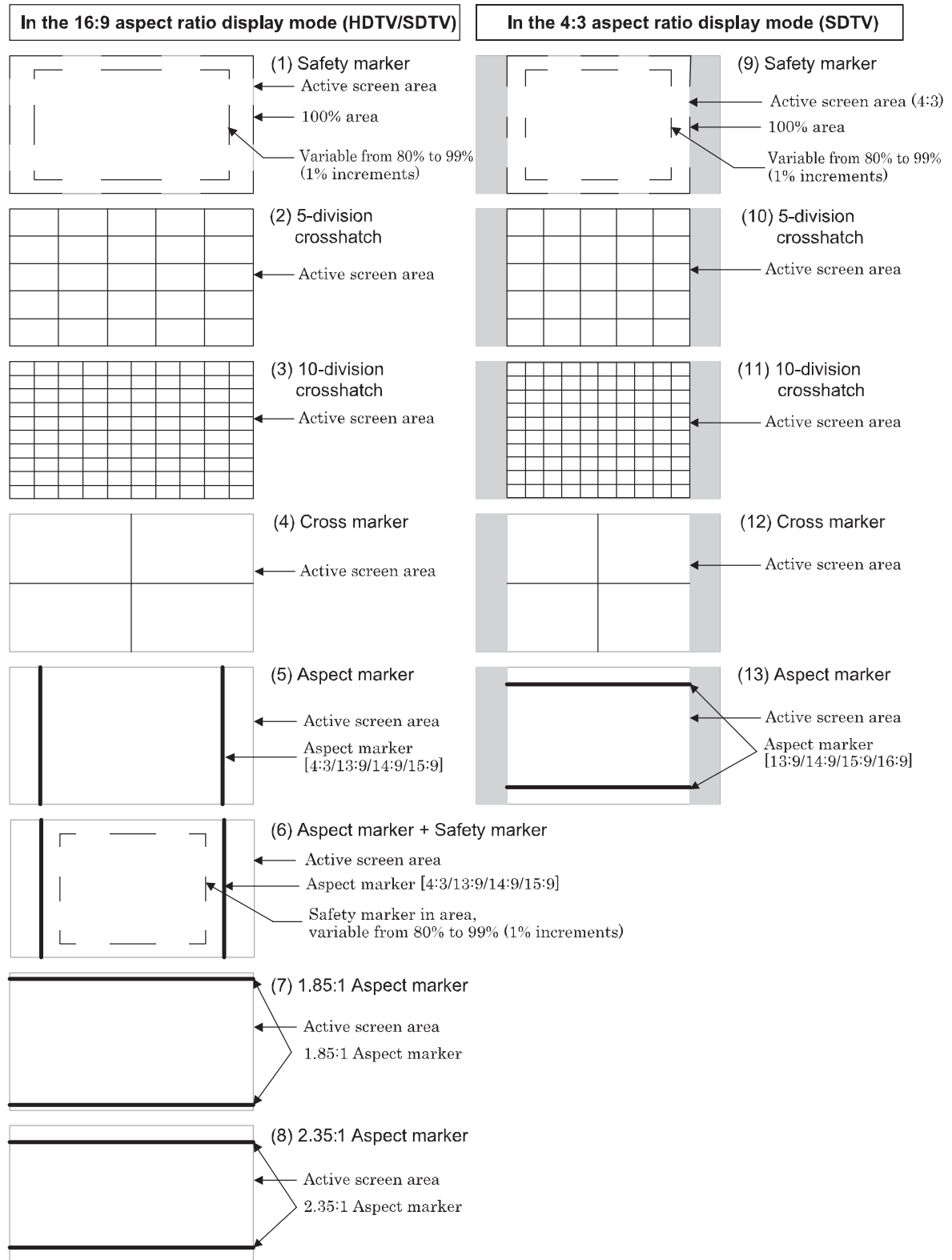

- The displayed markers are set on **MENU8**.
- With no menu onscreen, the image pattern can be changed with the and switches, whereas the safety marker percentage setting (1% increments) with the and switches.

4. MENU Functions

4-1. List of MENU

| | | | |
|------|-------------------------|--------------------------------|---|
| MENU | MENU1 (STATUS) | HEM-1770WR | Displaying the model name |
| | | >PRESET FILE | Setting file status |
| | | >COLOR SPACE | Color space setting status |
| | | >GAMMA | Gamma setting status |
| | | >FUNCTION1 MODE | F1 switch assignment status |
| | | >FUNCTION2 MODE | F2 switch assignment status |
| | | >FUNCTION3 MODE | F3 switch assignment status |
| | | >FUNCTION4 MODE | F4 switch assignment status |
| | >POWER ON STATUS | Power on status setting status | |
| | MENU2 (MODE-1) | 1.FUNCTION1 MODE | Setting the function assignment of F1(Function 1)switch |
| | | 2.FUNCTION2 MODE | Setting the function assignment of F2(Function 2)switch |
| | | 3.FUNCTION3 MODE | Setting the function assignment of F3(Function 3)switch |
| | | 4.FUNCTION4 MODE | Setting the function assignment of F4(Function 4)switch |
| | | 5.POWER ON STATUS | Setting the power on status ON/OFF |
| | | 6.→STATUS MEMORY | Executing the content that is stored in POWER ON STATUS |
| | MENU3 (MODE-2) | 1.REMOTE NO. | Setting the monitor ID code for remote control |
| | | 2.CHANGE ASPECT | Setting the automatic/manual aspect ratio change as per reception channel |
| | | 3.TALLY | Setting the tally lamp display format |
| | | 4.REAL SCAN | Setting the same-size (dot-by-dot) display ON/OFF |
| | | 5.SDI CH LOCK | Setting the SDI channel lock ON/OFF |
| | | 6.FORMAT DISPLAY | Setting the format display ON/OFF/TIMER at signal switching |
| | | 7.FRONT LIGHT | Setting the front light AUTO/ON/OFF |
| | | 8.→DIMMER | FRONT LIGHT dimming setting |
| | | 9.SCREEN SAVER | SCREEN SAVER operating time setting |
| | | 10.ZOOM WATCH | Executing the 2x/4x zoom function |
| | | 11.MIX TEST SIGNAL | Executing the MIX TEST SIGNAL function |
| | | 12.OSD BACKGROUND | Setting the OSD background |
| | | 13.BATTERY TYPE | Setting the type of battery (Displays in HEM-1770WR only) |
| | MENU4 (VITC/WFM/VSC) | 1.SDI VITC | Setting the SDI VITC display ON/OFF |
| | | 2.→DIMMER | Setting the SDI VITC display brightness |
| | | 3.→SIZE | Setting the SDI VITC display size |
| | | 4.WFM DISPLAY | Setting the waveform display ON/OFF |
| | | 5.→DIMMER | Setting the waveform display brightness |
| | | 6.→SIZE | Setting the waveform display size |
| | | 7.→POSITION | Setting the waveform display position (right/center/left) |
| | | 8.→COLOR | Setting the waveform display color (white/green) |
| | | 9.VECTOR SCOPE | Setting the VECTOR SCOPE display ON/OFF |
| | | 10.→DIMMER | Setting the VECTOR SCOPE display brightness |
| | | 11.→MAGNIFICATION | Setting the VECTOR SCOPE display magnification ratio |
| | | 12.→SCALE | Setting the COLOR BOX scale display (75%/100%) |
| | | 13.→POSITION | Setting the VECTOR SCOPE display position (right/center/left) |
| | | 14.→COLOR | Setting the VECTOR SCOPE display color (white/green) |

↓
(next page)

| | | |
|---------------------------|--------------------|--|
| MENU5 (SCREEN CAPTURE) | 1.SCR CAPTURE | Executing the 2-picture split mode |
| | 2.→AREA | Setting the 2-picture split mode display area |
| | 3.FUL CAPTURE | Executing the full capture mode |
| | 4.CHG MANUAL | Manual switching mode between full capture image and input signal image |
| | 5.CHG AUTO | Automatic switching mode between full capture image and input signal image |
| | 6.→INTERVAL | Setting up the interval of the automatic switching mode |
| | 7.USB FILE NO. | Setting the file number of the full capture image |
| | 8.WRIGHT TO USB | Writing the full capture image onto the USB memory |
| | 9.DOWNLOAD | Downloading from USB memory to monitor |
| MENU6 (VIDEO) | 1.CHROMA GAIN UP | Setting the chroma gain -up ON/OFF |
| | 2.→GAIN UP SELECT | Gain-up level (9dB/12dB) setting |
| | 3.IP MODE | Setting the IP conversion mode (FIELD/FRAME/INTERLACE) |
| | 4.SCAN MODE | Scan size (NORMAL/UNDER) setting |
| | 5.FLICKER LESS | Flickerless function ON/OFF setting |
| | 6.H POSITION | Adjusting the horizontal screen position |
| | 7.V POSITION | Adjusting the vertical screen position |
| | 8.CONTRAST RANGE | Setting the contrast range (Normal/Wide) |
| MENU7 (AUDIO) | 1.LINE/SP CH. | Setting the paired channels of embedded audio outputs |
| | 2.SP INPUT SEL | Setting the speaker output singals |
| | 3.AUDIO OUTPUT SEL | Setting the audio output singals |
| | 4.LEVEL INDICATOR | Setting the audio level meter display ON/OFF |
| | 5.→MODE | Setting the audio level meter display mode |
| | 6.→CHANNEL | Setting the audio level meter display channel |
| | 7.→DIMMER | Setting the audio level meter display brightness |
| | 8.→PEAK HOLD | Setting the audio level meter display peak hold |
| | 9.→REF LEVEL | Standard level setting (-18/-20dBFS) |
| | 10.DOWNMIX SETTING | Setting the 5.1 channel surround downmix |
| | 11.→FORMAT | Setting the downmix formats (ARIB/ISO IEC) |
| | 12.→Ls/Rs LEVEL | Setting the Ls/Rs level (-3dB/-6dB/-9dB/OFF) |
| | 13.→INPUT OF Lm | Setting the embedded audio channel assignment of speaker (Lm) |
| | 14.→INPUT OF Rm | Setting the embedded audio channel assignment of speaker (Rm) |
| | 15.→INPUT OF C | Setting the embedded audio channel assignment of speaker (C) |
| | 16.→INPUT OF Ls | Setting the embedded audio channel assignment of speaker (Ls) |
| | 17.→INPUT OF Rs | Setting the embedded audio channel assignment of speaker (Rs) |
| MENU8 (MARKER) | 1.MARKER (16:9) | Setting the type of marker displayed at 16:9 aspect ratio |
| | 2.→SAFRTY AREA | Setting the 16:9 safety marker area (80-99% (1% increments)) |
| | 3.→ASPECT | Setting the type of aspect marker at 16:9 display |
| | 4.→AREA IN ASPECT | Setting the safety marker (80-99% (1% increments)) in aspect marker area |
| | 5.MARKER (4:3) | Setting the type of marker displayed at 4:3 aspect ratio |
| | 6.→SAFETY AREA | Setting the 4:3 safety marker (80-99% (1% increments)) |
| | 7.→ASPECT | Setting the type of aspect marker at 4:3 display |
| | 8.ASP MARKER MODE | Setting the aspect marker display mode |
| | 9.→SHADOW LEVEL | Setting the shadow contrast level with shadow on screen |
| | 10.CENTER MARKER | Setting the center cross marker ON/OFF |
| | 11.MARKER LEVEL | Setting the marker display level |
| | 12.MARKER COLOR | Setting the marker display color |
| | 13.USER MARKER | Setting the user marker display ON/OFF |
| | 14.→SCENE NAME | Selecting each scene of user markers and setting the scene names. |
| | 15.→SETTING | Executing the user marker for the drawing setting menu |

(next page)

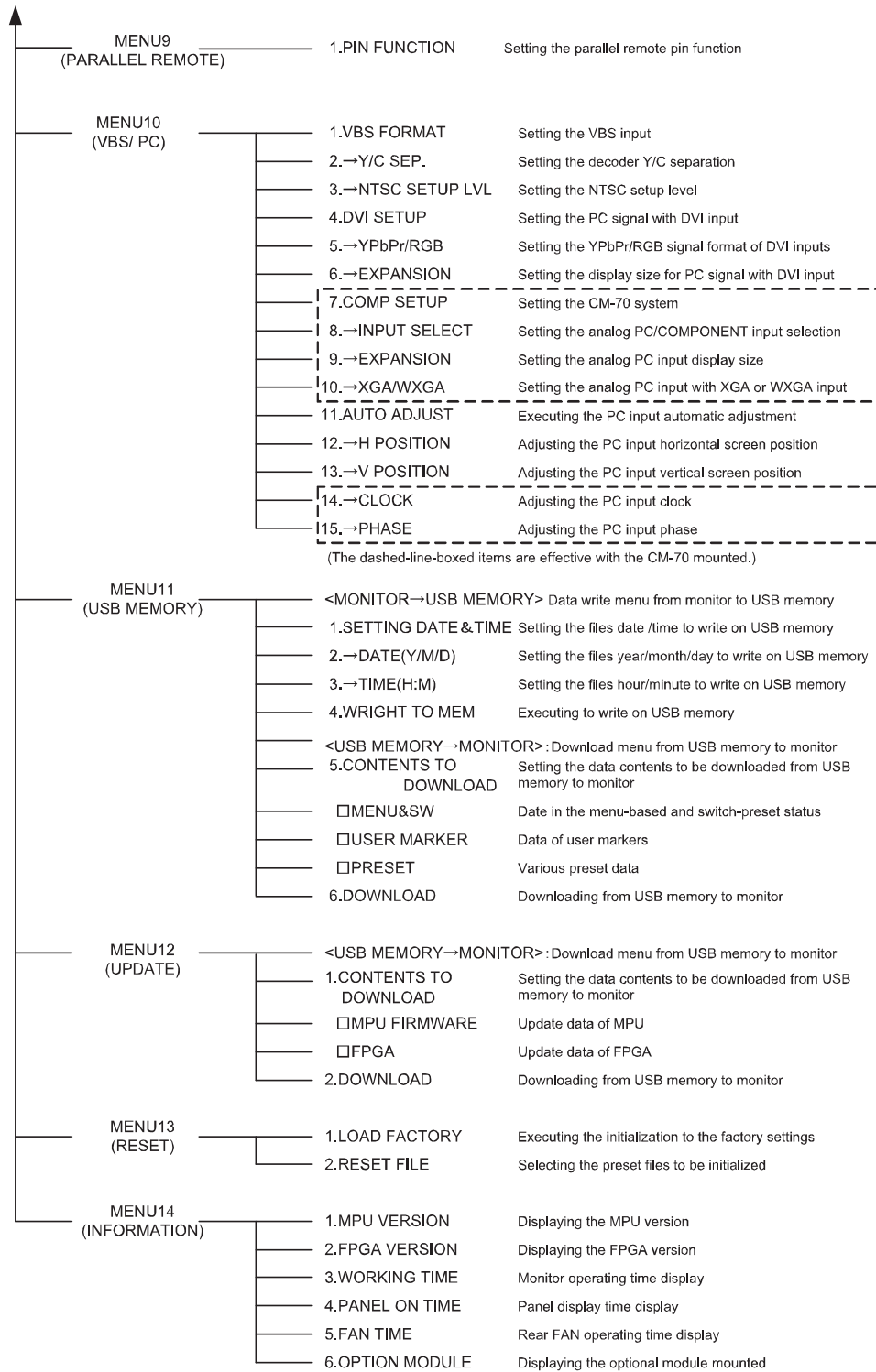

4-2. Flow of MENU Operations

MENU can be switched as follows using the **MENU** switch.

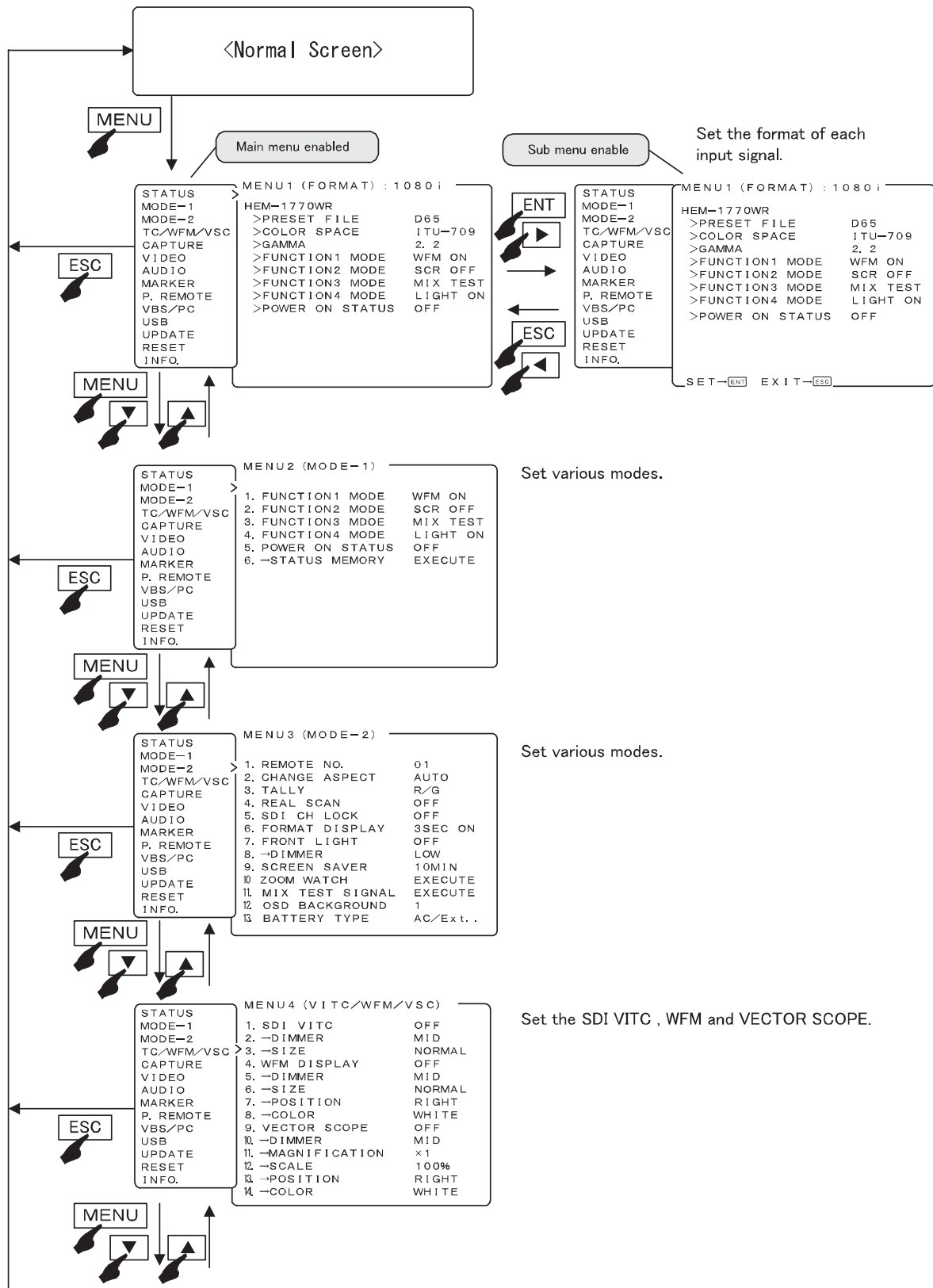

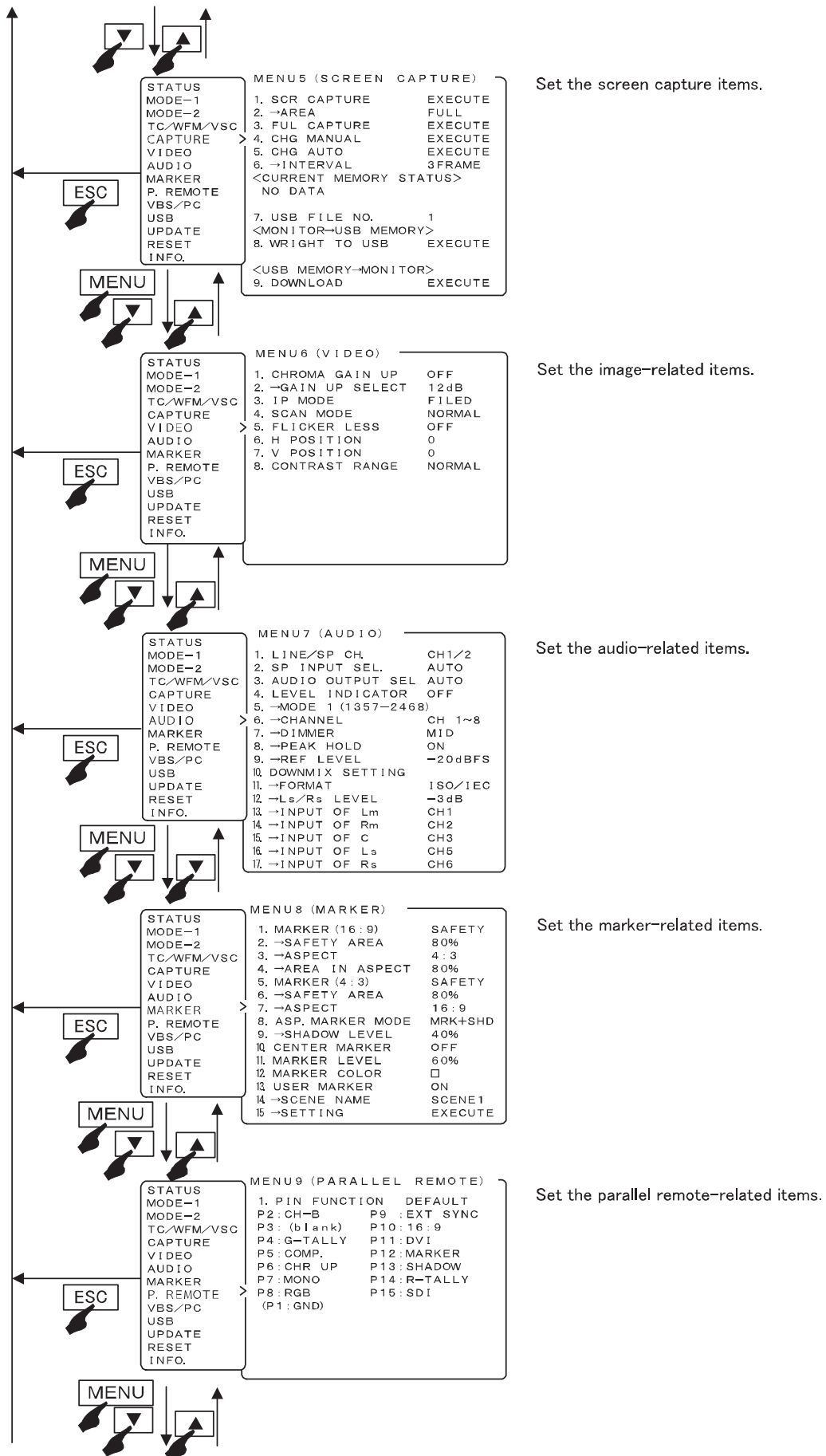

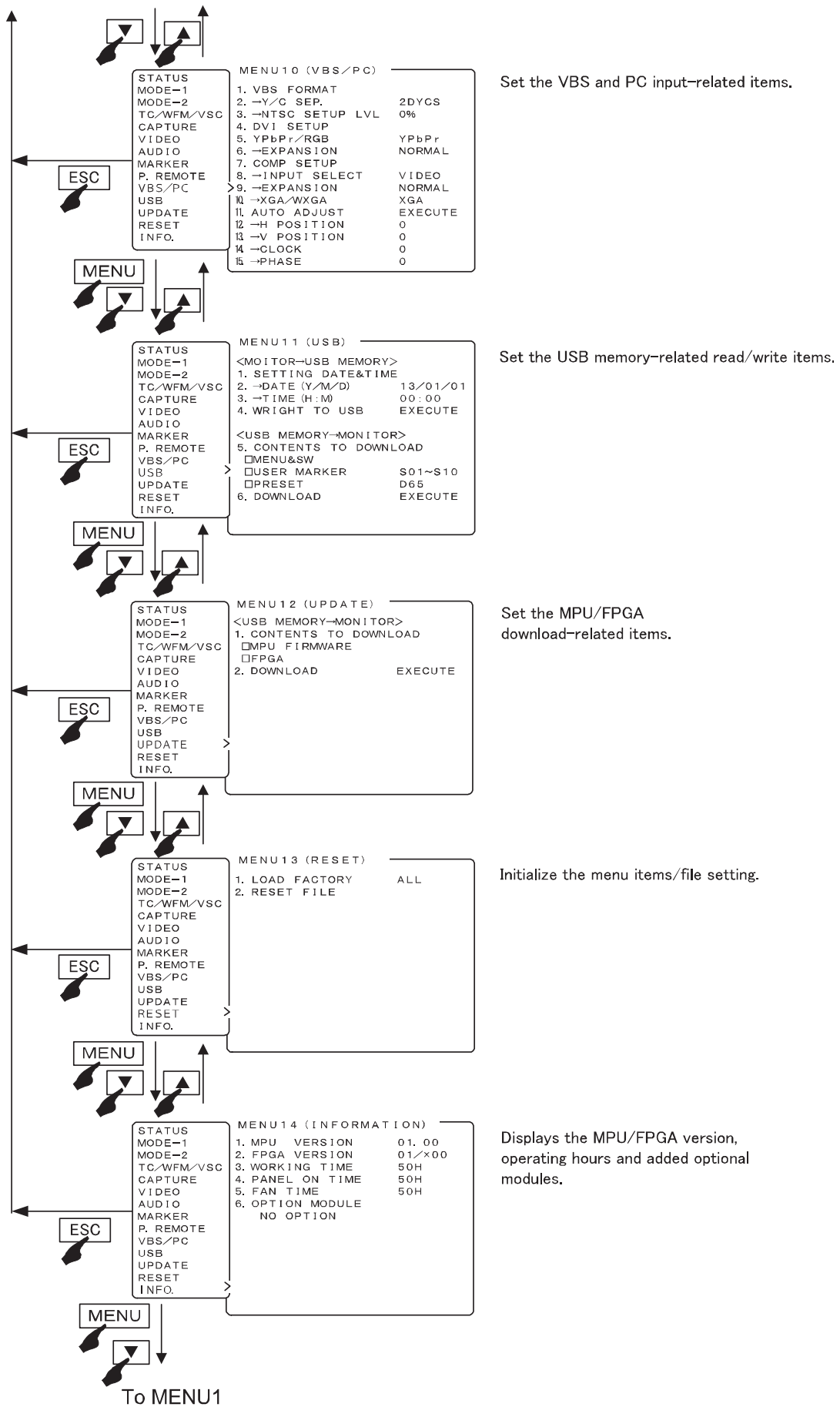

4-3. Description of MENU 1 Functions

* Note the following description on the menu.

- The vertical frequency “/60” includes both 60 Hz and 59.94 Hz (60/1.001).
- The vertical frequency “/48” includes both 24 psF and 23.98 psF (24/1.001).
- The vertical frequency “/24” includes both 24 Hz and 23.98 Hz (24/1.001).

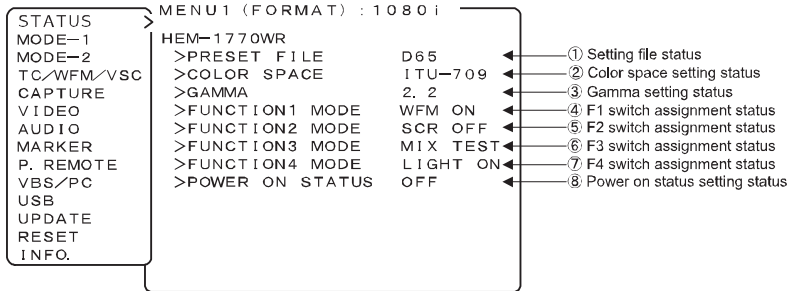

① Setting file status

- The status of FILE (D65, D93, and FILE 1 to 8) that was set in "SELECT FILE" of the PRESET MENU-1 section is displayed here.

② Color space setting status

- The status of COLOR SPACE (ITU-709, EBU, SMPTE-C and PANEL) that was set in "COLOR SPACE" of the PRESET MENU-2 section is displayed here.

③ Gamma setting status

- The status of GAMMA (2.2, 2.4 and CRT) that was set in "CHANGE DATA" of the PRESET MENU-3 section is displayed here.

④ F1 switch assignment status

- The function that was set in "FUNCTION1 MODE" of the MENU2-1 section is displayed here.

⑤ F2 switch assignment status

- The function that was set in "FUNCTION2 MODE" of the MENU2-2 section is displayed here.

⑥ F3 switch assignment status

- The function that was set in "FUNCTION3 MODE" of the MENU2-3 section is displayed here.

⑦ F4 switch assignment status

- The function that was set in "FUNCTION4 MODE" of the MENU2-4 section is displayed here.

⑧ Power on status setting status

- The ON/OFF status that was set in "POWER ON STATUS" of the MENU2-5 section is displayed here.

4-4. Description of MENU 2 Functions

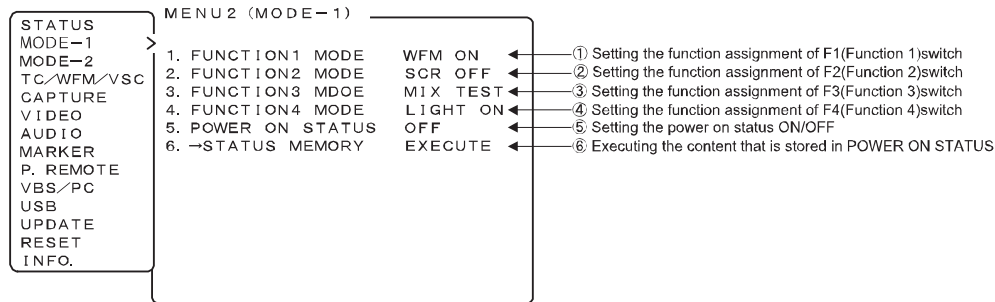

① Setting the function assignment of F1 switch

- Set any of the following operations performed by pressing the **F1** switch on the front panel.

• Default setting is WFM ON.

- The function assigned for each function switch is as follows.

< F1 to F4 SW Function Assignment List >

- FILE Switching of the preset file
D65 → D93 → FILE1 → FILE2 →
- MRK SEL Switching of the types of marker
SAFETY → CROSS 5 → ASP+SAF →
- COMB Switching of the Decoder Y/C separation setting
2DYCS → 3DYCS → TRAP →
*PAL: 2DYCS → TRAP →
- CHR UP Turning ON/OFF of CROMA UP
CHROMA UP ON → OFF →
- DELAY Switching of H/V/H+V of DELAY
Enabled only for SDI input
H.DL → V.DL → H/V.DL → DL OFF
- IP MODE Switching of the IP
FIELD/FIELD/INTERLACE conversion mode
FRAM → FIELD → INTERLACE →
- RS ON Turning ON/OFF of the equal magnification display
RS ON → OFF →
- USR MRK Switching of the USER MARKER SCENES
SCENE1 → 2 → 3 → . . . 10 → OFF →
- VSC ON Turning ON/OFF of the VECTOR display
VSC ON → OFF →
- VITC ON Turning ON/OFF of the SDI VITC display
VITC ON → OFF →
- WFM ON Turning ON/OFF of the WFM display
WFM ON → OFF →
- AUD CH Switching of the embedded audio channel
CH1/2 → CH3/4 → CH5/6 → CH7/8 → DMIX →
- FCAP Capturing of full-screen images
Shortcut key to the Image Capture Menu

- CHG M Manual switching of a full capture image and the input signal image
Shortcut key to the Execution Menu
* It will not operate unless the image is captured in advance.
 - CHGA Automatic switching of a full capture image and the input signal image
Shortcut key to the Execution Menu
* It will not operate unless the image is captured in advance.
 - PRESET A shortcut key to PRESET MENU for white balance adjustment.
 - ASPECT Switches between 4:3 and 16:9 during the SD signal.
ASPECT 4:3 → 16:9 →
 - SCAN Switching of the NORMAL/UNDER SCAN
UNDER SCAN → NORMAL SCAN →
 - SCR OFF Screen display OFF function.
SCREEN OFF → ON →
 - LIGHT ON Switches ON/OFF the front panel lighting
LIGHT ON → OFF →
 - MIX TEST Switches ON/OFF the MIX TEST SIGNAL function.
MIX TEST SIGNAL ON → OFF
- * "DELAY" will not be operated with PC signal, DVI (PC) signal, or VBS signal. During the DELAY, it will be the same magnification display (dot by dot) so that the scaling process is not performed.

② Setting the function assignment of F2 switch

- The function assignment is selectable in the same way as that shown above ① by pressing the **F2** switch on the front panel.
- Default setting is SCR OFF.

③ Setting the function assignment of F3 switch

- The function assignment is selectable in the same way as that shown above ① by pressing the **F3** switch on the front panel.
- Default setting is MIX TEST.

④ Setting the function assignment of F4 switch

- The function assignment is selectable in the same way as that shown above ① by pressing the **F4** switch on the front panel.
- Default setting is LIGHT ON.

⑤ Setting the power on status ON/OFF

- Even if another person changes the setting without permission, you can use this function to revert the setting anytime by turning on the power again. This function is convenient if multiple people are involved in the operation.
- If this function is set to "ON", all settings and data that had been changed before the power was turned off are cleared, and the setting items and data for the MENU and PRESET MENU that are stored in the "STATUS MEMORY" of the section 6 are loaded.
- When it is set to "OFF", the setting status is displayed the same as it was before the power is turned OFF.
- * If "LOAD FACTORY" of MENU13 is executed, the contents stored in "STATUS MEMORY" will be cleared.
- Default setting is OFF.

⑥ Executing the content that is stored in POWER ON STATUS

- The items to be stored in "POWER ON STATUS" are executed here.
- When the "STATUS MEMORY" is executed, the setting items for the MENU and PRESET MENU are stored (except some of the following items). If the power is turned on with the "POWER ON STATUS: ON" setting, all items that are stored here will be loaded.
- * The items that will not be stored in POWER ON STATUS.
 - Internal gamma table value when the color temperature adjustment is executed by APS-100
 - User marker setting value
 - The setting value of "H POSITION" and "V POSITION" to be set in the MENU6 section.

4-5. Description of MENU 3 Functions

| STATUS | MENU 3 (MODE-2) | | |
|------------|---------------------|------------|---|
| MODE-1 | 1. REMOTE NO. | 01 | ① Setting the monitor ID code for remote control |
| MODE-2 | 2. CHANGE ASPECT | AUTO | ② Setting the automatic/manual aspect ratio change as per reception channel |
| TC/WFM/VSC | 3. TALLY | R/G | ③ Setting the tally lamp display format |
| CAPTURE | 4. REAL SCAN | OFF | ④ Setting the same-size (dot-by-dot) display ON/OFF |
| VIDEO | 5. SDI CH LOCK | OFF | ⑤ Setting the SDI channel lock ON/OFF |
| AUDIO | 6. FORMAT DISPLAY | 3SEC ON | ⑥ Setting the format display ON/OFF/TIMER at signal switching |
| MARKER | 7. FRONT LIGHT | OFF | ⑦ Setting the front light AUTO/ON/OFF |
| P. REMOTE | 8. -DIMMER | LOW | ⑧ FRONT LIGHT dimming setting |
| VBS/PC | 9. SCREEN SAVER | 10MIN | ⑨ SCREEN SAVER operating time setting |
| USB | 10. ZOOM WATCH | EXECUTE | ⑩ Executing the 2x/4x zoom function |
| UPDATE | 11. MIX TEST SIGNAL | EXECUTE | ⑪ Executing the MIX TEST SIGNAL function |
| RESET | 12. OSD BACKGROUND | 1 | ⑫ Setting the OSD background |
| INFO. | 13. BATTERY TYPE | AC/E x t . | ⑬ Setting the type of battery (Displays in HEM-1770WR only) |

① Setting the serial remote control ID number

- Used to set the ID number (01 to 99) of the monitor.
- The ID number is assigned to each monitor in order to perform remote operation with the infrared remote controller (RCT-20A/30A) and serial remote controller (SRC-400* Under development).

• Default setting is 01.

② Setting the ASPECT ratio to Automatic or Manual

- Used to select the automatic setting of a preset aspect ratio or the fixed setting for all reception channels, when selecting any reception channel.
- AUTO : displayed with the set aspect ratio for each channel
- MANUAL : displayed with the same aspect ratio for all channels

• Default setting is AUTO.

* When switching the ASPECT in the parallel remote mode, set the ASPECT ratio to "MANUAL".

③ Setting the tally lamp indication

- Set any of the following display modes of the tally lamps located at the top of the front of the monitor.
- R/G : R is on the left side and G on the right side, when facing the screen.

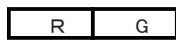

[R-TALLY ON] [G-TALLY ON]

- G/R : G is on the left side and R on the right side, when facing the screen.



[G-TALLY ON] [R-TALLY ON]

- R+G : The entire tally is displayed.

The lamp is displayed in amber when both the R-TALLY and G-TALLY are set at ON. Both R- and G-TALLY at ON.

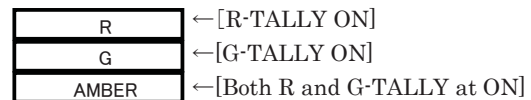

- R/G ALL : Displays the entire TALLY only when it is solely set to ON.

If both R-TALLY and G-TALLY are set to ON, they will be displayed on the left and right sides.

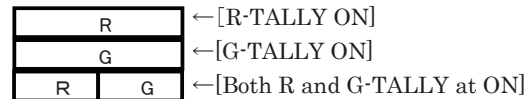

- G/R ALL : Displays the entire TALLY only when it is solely set to ON.

If both R-TALLY and G-TALLY are set to ON, they will be displayed on the left and right sides.

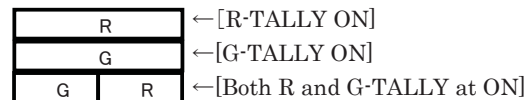

• Default setting is R/G.

④ Setting the same-size (dot-by-dot) display ON/OFF

- Set to ON in order to reproduce the input signal in its original pixels without enlargement or reduction.

• This function can be assigned with the **F1** to **F4** switch on the front panel.

• Default setting is OFF.

※Signals in 480i/575i format are not in square pixels. Therefore, the aspect ratio will be displayed differently from the original image.

⑤ **Setting the SDI channel switching lock ON/OFF**

- If you want to prevent the switching between A/B channels of SDI signal from switching, set it to "ON", and then fix the input channel.
- It utilizes the MONITOR OUT terminal and is effective in fixing the channel. It prevents accidental channel switching.
- Default setting is OFF.
- * Before setting it to "ON", make sure the desired SDI channel is selected.

⑥ **Setting the format display ON/OFF before switching signals**

- Used to set whether the channel and signal format are displayed or not.
- 3SEC ON : Three seconds indication
- CONT ON : Consecutive indication
- OFF : Indication off
- Default setting is 3SEC ON.

⑦ **Setting the front light AUTO/ON/OFF**

- Sets the light-up method of front lighting.
- AUTO: Automatically turns off unless the front operation is done.
- ON: Always turned on
- OFF: Always turned off
- This function can be assigned with the **F1** to **F4** switch on the front panel.
- Default setting is AUTO.

⑧ **FRONT LIGHT dimming setting**

- Sets the brightness of front lighting on two levels: LOW and HIGH.
- Default setting is LOW.

⑨ **SCREEN SAVER operating time setting**

- The screen saver prevents the burn-in of OLED panel caused by a long-term display of still picture pattern. When the same still pictures are continuously displayed for the amount of time that is set here, the screen is automatically turned off.
- The operation time of screen saver is selected from "10MIN, 30 MIN, 60MIN, and OFF".
- When the image is changed or changed to a video or the front part is operated, the screen saver is canceled. Then the image will be displayed. If the image is the scrolling of still pictures, the SCREEN SAVER will not be canceled.
- Default setting is 10MIN.

⑩ **Executing the 2x/4x zoom function**

- A function used to enlarge the image 2x or 4x without screening.
- You can check for any scratch on the CCD of camera or for the delicate images.
- The display area to be enlarged is displayed on the left bottom of the screen.

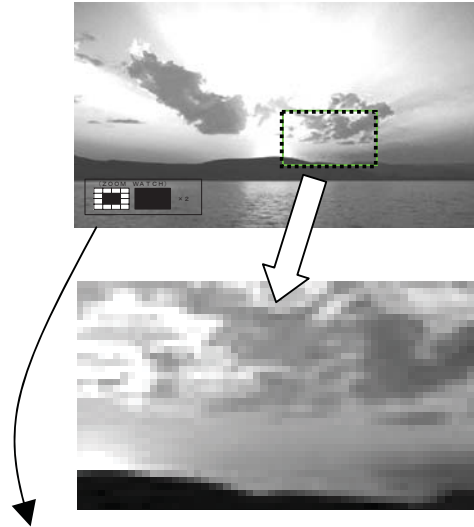

- The ENT switch is used to switch between 2x and 4x.

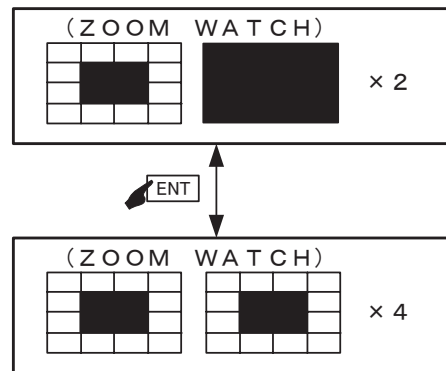

⑪ **Executing the MIX TEST SIGNAL function**

- By mixing the pluge signal (-2%/0%/+2%) and 100% to 109% signal into the image, you can adjust the image in real time by checking if white part is filled out due to the CONTRAST adjustment for the over 100% signal or if there is no "black sun" effect caused by the BRIGHTNESS adjustment.
- This device automatically turns off the display when the front volume is not operated for approximately one minute.
- This function can be assigned with the **F1** to **F4** switch on the front panel.
- Default setting is OFF.

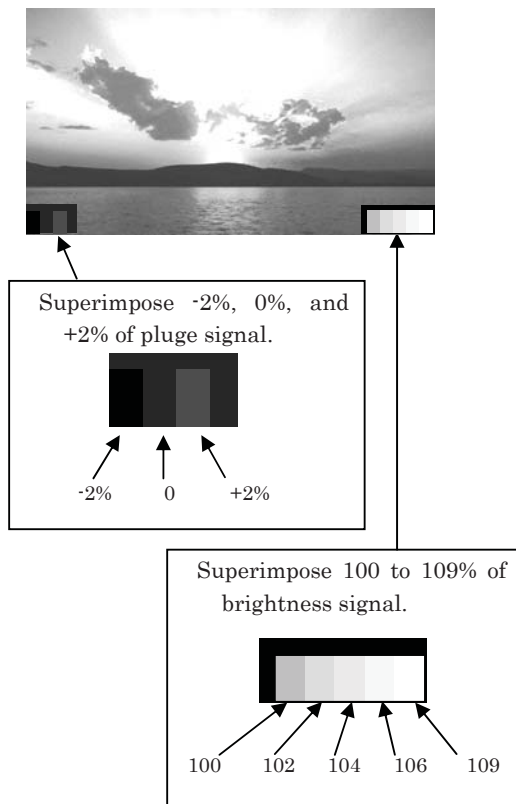

⑫ OSD background transparency setting

- The background for displaying the OSD can be set on 3 levels: 1 (semi-transparent) to 3 (transparent).
- Default setting is 1 (semi-transparent).

⑪ Setting the type of battery (HEM-1770WR only)

- This function is used to set the voltage (discharge ending voltage) for warning that the battery is low. Select an appropriate mode according to the nominal voltage of the battery to be used.
 - AC/Ext. : AC or external stabilized DC power supply
 - DC+14.8V : Battery with nominal voltage of 14.8V or 14.4V
 - DC+13.2V : Battery with nominal voltage of 13.2V
 - DC+12.0V : Battery with nominal voltage of 12.0V
- Default setting is AC/Ext.

Precautions for battery

- 1) For the nominal voltage of the battery, refer to the indication on the battery or the instructions manual of the battery.
- 2) For the following batteries, select DC +14.8V in the battery mode setting.
endura 9,9S by IDX CO., Ltd.
- 3) When using the battery equipped with XLR 4-pin connector or when operating the battery using XLR 4-pin connector, make a proper selection in the battery setting according to the nominal voltage of the battery used.
Example: HP-90L by Paco Electronics Industry, Inc. : DC+13.2V
- 4) When operated with the setting not in accordance with the battery's nominal voltage, the following events may result.
 - When nominal 13.2V battery is used with +DC12V setting.
Battery alarm, 30-second alarm and shutdown alarm will function. However, it may take longer from activation of the battery alarm until shutdown.
Also, the battery life may be adversely affected as the voltage is lower than the discharge ending voltage.
 - When nominal 13.2V battery is used with +DC14.8V setting.
Service hours are shortened.
 - When nominal 12.0V battery is used with +DC14.8V setting.
Battery alarm and 30-second alarm may be triggered shortly even if fully charged battery is used, shutting down the monitor.
- 5) If operation is stopped shortly despite correct battery mode setting (shutdown alarm will not flicker), it is likely that the battery's internal protection circuit has been activated.

4-6. Description of MENU 4 Functions

| STATUS | MENU 4 (VITC/WFM/VSC) | | |
|------------|-----------------------|--------|--|
| MODE-1 | 1. SDI VITC | OFF | ① Setting the SDI VITC display ON/OFF |
| MODE-2 | 2. →DIMMER | MID | ② Setting the SDI VITC display brightness |
| TC/WFM/VSC | 3. →SIZE | NORMAL | ③ Setting the SDI VITC display size |
| CAPTURE | 4. WFM DISPLAY | OFF | ④ Setting the waveform display ON/OFF |
| VIDEO | 5. →DIMMER | MID | ⑤ Setting the waveform display brightness |
| AUDIO | 6. →SIZE | NORMAL | ⑥ Setting the waveform display size |
| MARKER | 7. →POSITION | RIGHT | ⑦ Setting the waveform display position |
| P. REMOTE | 8. →COLOR | WHITE | ⑧ Setting the waveform display color |
| VBS/PC | 9. VECTOR SCOPE | OFF | ⑨ Setting the VECTOR SCOPE display ON/OFF |
| USB | 10. →DIMMER | MID | ⑩ Setting the VECTOR SCOPE display brightness |
| UPDATE | 11. →MAGNIFICATION | ×1 | ⑪ Setting the VECTOR SCOPE display magnification ratio |
| RESET | 12. →SCALE | 100% | ⑫ Setting the COLOR BOX scale display |
| INFO. | 13. →POSITION | RIGHT | ⑬ Setting the VECTOR SCOPE display position |
| | 14. →COLOR | WHITE | ⑭ Setting the VECTOR SCOPE display color (white/green) |

① Setting the SDI VITC display ON/OFF

- Used to turn ON or OFF the VITC display multiplexed with HD-SDI signal.
- This function can be assigned with the **F1** to **F4** switch on the front panel.
- Default setting is OFF.

② Setting of SDI VITC display brightness

- Used to set the SDI VITC display brightness in three levels, LOW, MID and HIGH.
- Default setting is MID.

③ Setting of SDI VITC display size

- Used to select the SDI VITC display size, NORMAL or LARGE.
- Default setting is NORMAL.

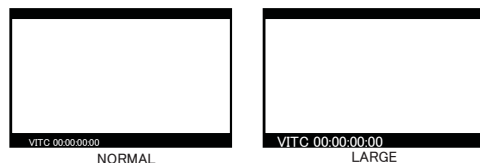

④ Setting of waveform display ON/OFF

- Used to turn ON or OFF the waveform display of luminance signal.
- This function can be assigned with the **F1** to **F4** switch on the front panel.
- Default setting is OFF.

⑤ Setting of waveform display brightness

- Used to set the waveform display brightness in three levels, LOW, MID, HIGH and HIGH(M).
- HIGH(M) mode transmits with a picture and displays it.
- Default setting is MID.

⑥ Setting of waveform display size

- Used to set the luminance signal waveform display size, NORMAL or SMALL.
- The SMALL setting displays the waveform half as tall as in the NORMAL setting.
- Default setting is NORMAL.

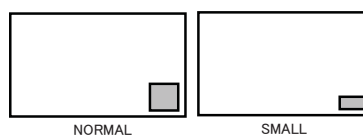

⑦ Setting of waveform display position

- Used to set the waveform display position, RIGHT, CENTER or LEFT.
- Default setting is RIGHT.

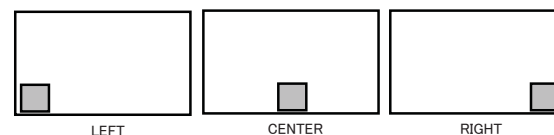

⑧ Setting of waveform display color

- Used to set the waveform display color, GREEN or WHITE.
- Default setting is WHITE.

⑨ **Setting the VECTOR SCOPE display ON/OFF**

- Used to turn on or off the VECTOR SCOPE display.
- This function can be assigned with the **F1** to **F4** switch on the front panel.
- Default setting is OFF.

⑩ **Setting the VECTOR SCOPE display brightness**

- Used to set the VECTOR SCOPE display brightness in 3 levels: LOW, MID, HIGH and HIGH(M).
- HIGH(M) mode transmits with a picture and displays it.
- Default setting is MID.

⑪ **Setting the VECTOR SCOPE display magnification ratio**

- Used to set the VECTOR SCOPE display magnification in 4 ratios: x1, x2, x4 and x8.
- Default setting is x1.

⑫ **Setting the COLOR BOX scale display**

- Used to set the VECTOR SCOPE's COLOR BOX according to the input color bar signal: 75% and 100%.
- Default setting is 100%.

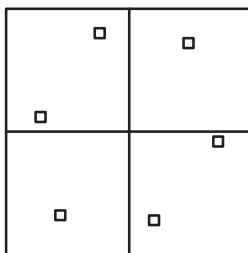

75%SCALE

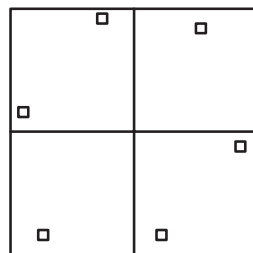

100%SCALE

⑬ **Setting the VECTOR SCOPE display position**

- Used to set the waveform display to any of the RIGHT, CENTER and LEFT positions.
- When used commonly with WFM, the VECTOR display is located on the left of the WFM one.
- Default setting is RIGHT.

- RIGHT location

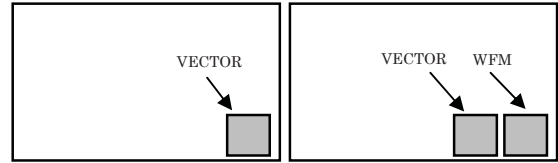

- CENTER location

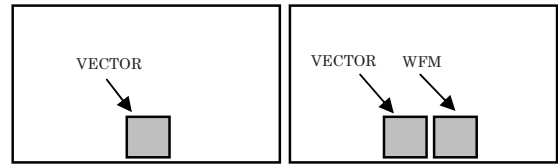

- LEFT location

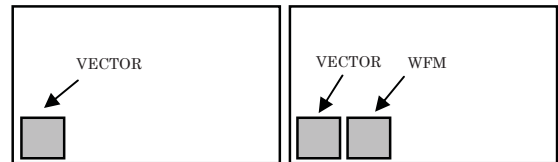

⑭ **Setting the VECTOR SCOPE display color**

- Used to set the waveform display color to either of GREEN and WHITE.
- Default setting is WHITE.

4-7. Description of MENU 5 Functions

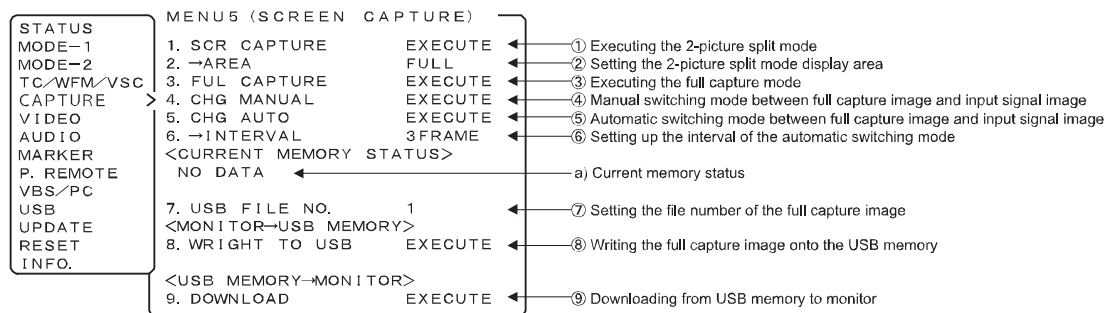

① Executing the 2-picture split mode

- Used to execute this mode to take in the still image of an input signal and compare it with other inputs.

- With "EXECUTE" flashing in magenta, press the **ENT** switch.
- The display changes as shown below. Press the **ENT** switch again to take in the image.

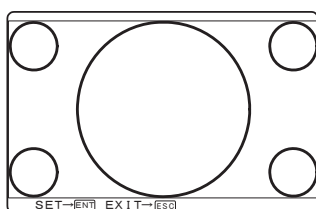

- Switch the input and compare its image with the taken-in still image. To take in another image or to quit the 2-picture split mode, press the **ESC** switch.

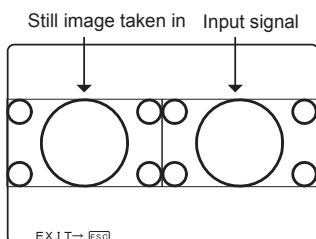

- The 2-picture split mode is operative with the same format signals. If different-format signals are input, the images cannot be properly displayed.
- With ASPECT set at [16:9], the SDTV signal is converted to the [4:3].

② Setting of 2-picture split display area

- Used to set the display area in the 2-picture split mode.
 - FULL: Full image displayed
 - 4:3: Image in the central 4:3 area displayed
 - Default setting is FULL.

- This function is operative with HDTV-format input signals only.

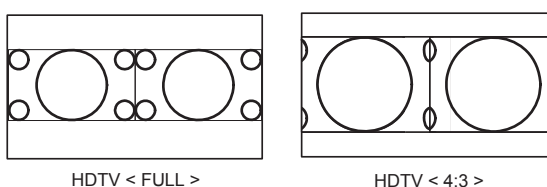

③ Executing the full capture mode

- This mode enables capturing the image that has been input in the full-screen mode.
- When the EXECUTE command is given, the MENU will appear at the lower left hand corner of the screen. When the **ENT** switch is pressed, the full screen image will be captured. By pressing the **ESC** switch, the Input Signal mode will be resumed.

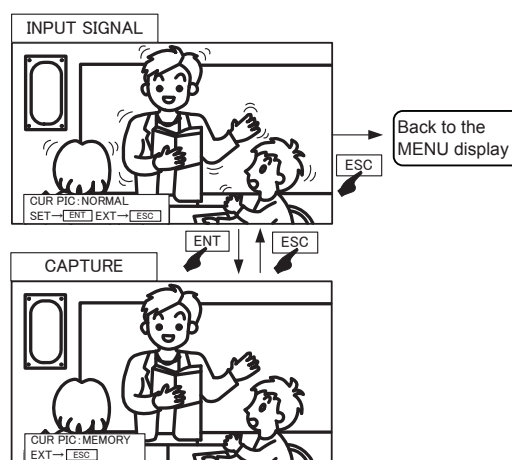

- This function can be assigned with the **F1** to **F4** switch on the front panel.
- When the power is turned OFF, the captured image will be lost. If it is desired to save it for future use, follow item ⑧ to store it in the USB memory, and download it from the memory when using it.

④ Manual switching mode between full capture image and input signal image

- This operation is possible after the full capture mode described under item ③ has been executed.
- Whenever the **ENT** switch is pressed, the full capture image and the image of the input signal will be instantly switched over as illustrated on the diagram at left, making it possible immediately to compare the images.

By selecting a preferred moment to change over the switch, it is possible to ascertain the comparison of color / brightness / picture quality / position, etc. on a partial basis.

- This function can be assigned with the **F1** to **F4** switch on the front panel.
- * The comparison of the image of the input signal and the captured image can be performed only if both images are in the same format. The comparison cannot be performed if the formats of images of the input signal and the captured image are different, or if the captured image has not been stored in the memory of the monitor.

⑤ Automatic switching mode between full capture image and input signal image

- This operation is possible after the full capture mode described under item ③ has been executed.
- The full capture image and the image of the input signal will be automatically switched over, making it possible immediately to compare the images.

As images are switched over automatically, it is possible to carry out adjustments such as positioning at ease while operating the camera.

- The automatic switching can be set up by frame according to the procedures described under item ⑥.
- This function can be assigned with the **F1** to **F4** switch on the front panel.
- * The comparison of the image of the input signal and the capture image can be performed only if both images are in the same format. The comparison cannot be performed if the formats of the input signal image and the capture image should differ, or if the captured image has not been stored in the memory of the monitor.

⑥ Setting up the interval of the automatic switching mode

- This operation is possible after the full capture mode described under item ③ has been executed.
- The interval of the automatic switching mode can be specified by a unit of frame as shown below: .
1 FRAME→2 FRAMES→3 FRAMES→5 FRAMES
→10 FRAMES→30 FRAMES→60 FRAMES→

- Default setting is 3 FRAMES.

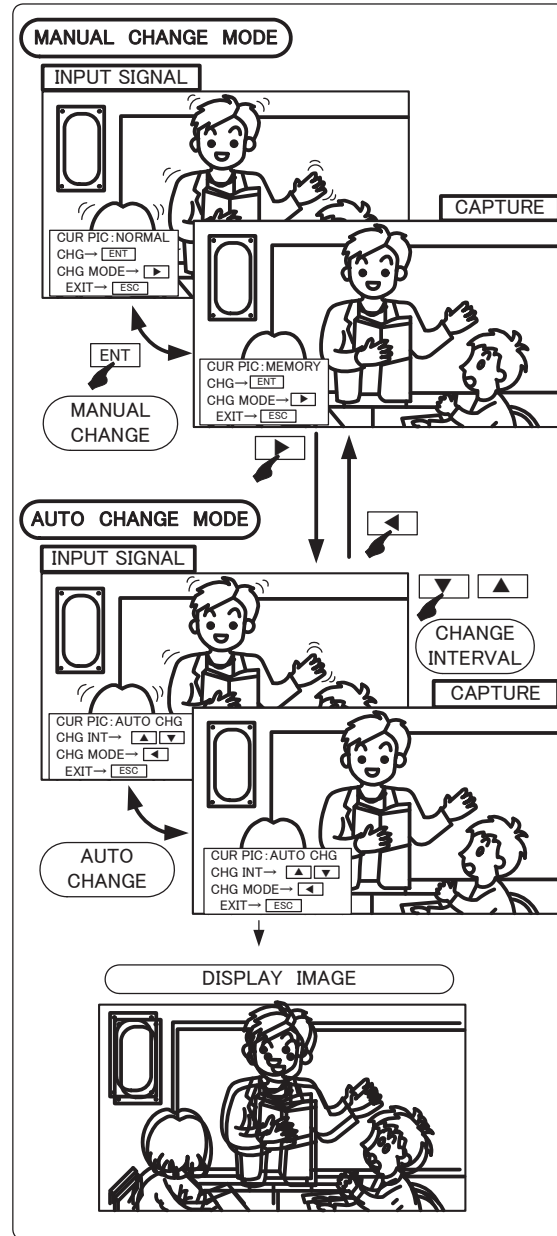

a) CURRENT MEMORY STATUS

- The format of the full capture image is displayed here.
- The "NO DATA" display will appear when no image has been captured. As all captured images will be lost when the monitor is turned OFF, the "NO DATA" display will always appear whenever the monitor is turned ON.

⑦ Setting the file number of the full capture image

- This feature is used to specify the file number (1~100) to be used when storing a full capture image in the USB memory. When downloading an image from the USB memory, one of these numbers is used to identify the desired image file.

⑧ Writing the full capture image onto the UBS memory

- Since it is possible to take in up to 100 images, test signals and other required images can be stored in the USB memory in advance before going out on an outdoor filming work for downloading and utilizing them on the location site.
- In case data is to be stored in PC and be restored onto the USB memory, make sure that the entire folder of “Ikegami_Monitor” containing the required data should be placed on the root of the USB.
- The USB memories in any format other than FAT12/16/32, or VFFFT are not compatible with this monitor. In addition, any USB memory on which some security measure has been executed cannot be used on this monitor.
- It takes approximately 1 minute and 20 seconds to write.
- For details of the method of writing data on the USB memory, please refer to “How to write full capture data from monitor to USB memory” on page 29.

Concerning file names

- When a full capture image is stored in the USB memory, a folder called “Ikegami_Monitor” will be automatically created in the USB memory, in which files will be stored as described below. If the USB memory has been already manipulated under **MENU11**, the “Ikegami_Monitor” folder should already have been created. The subsequent image files will be stored in this folder in binary format.
- The file format is dedicated to the monitor, and it is a common file for HEM-1770WR, HEM-2570W, and HLM-1751WR.

Concerning dates used for stored files

- Since the monitor does not have any built-in clock, “the date,” and “the time” that have been set up under **MENU11** will apply. Please check the descriptions given under **MENU11** for the method of setting.

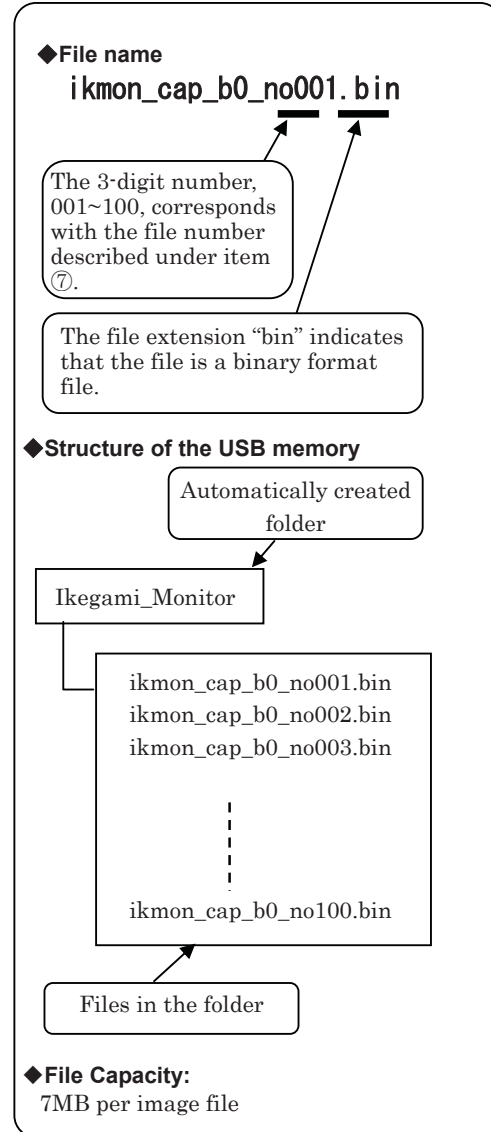

⑨ Downloading from UBS memory to monitor

- Downloading the capture image stored in the USB memory to the monitor
- It takes approximately 1 minute and 20 seconds to download.
- For details of the method of downloading the capture image from the USB memory to the monitor, please refer to “How to download full capture data from USB memory to monitor” on page 30.

How to write of full capture data from monitor to USB memory

```

MENU5 (SCREEN CAPTURE)
<CURRENT MEMORY STATUS>
1080i/60
7. USB FILE NO. 1
<MONITOR-USB MEMORY>
8. WRITE TO MEMORY EXECUTE
<USB MEMORY-MONITOR>
9. DOWNLOAD EXECUTE
SET-ENT EXIT-ESC
    
```

Setting the file number to write in to USB memory.

◆Precaution
 Do not draw out the inserted USB memory until the writing has been completed. If drawn out during access, the device may get damaged.
 The USB memory use USB memory formatted in FAT12/16/32, VFAT.
 The USB cannot use USB memory with the security software.

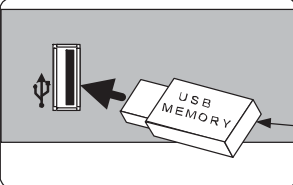

Insert a USB memory into the USB port at the monitor front.

```

MENU5 (SCREEN CAPTURE)
<CURRENT MEMORY STATUS>
1080i/60
7. USB FILE NO. 1
<MONITOR-USB MEMORY>
8. WRITE TO MEMORY EXECUTE
<USB MEMORY-MONITOR>
9. DOWNLOAD EXECUTE
SET-ENT EXIT-ESC
    
```

Move the cursor to "EXECUTE" and press the ENT switch.

By pressing the ESC switch at this point, the device is disconnected and the USB memory can be drawn out.

When no USB memory is inserted:

```

MENU5 (SCREEN CAPTURE)
<CURRENT MEMORY STATUS>
1080i/60
7. USB FILE NO. 1
<MONITOR-USB MEMORY>
8. WRITE TO MEMORY EXECUTE
<USB MEMORY-MONITOR>
9. DOWNLOAD EXECUTE
DEVICE NO CONNECT
SET USB MEMORY
CANCEL-ESC
    
```

The "NO CONNECT" message appears.

When an unsupported device is inserted:

```

MENU5 (SCREEN CAPTURE)
<CURRENT MEMORY STATUS>
1080i/60
7. USB FILE NO. 1
<MONITOR-USB MEMORY>
8. WRITE TO MEMORY EXECUTE
<USB MEMORY-MONITOR>
9. DOWNLOAD EXECUTE
DEVICE UNSUPPORTED
SET USB MEMORY
CANCEL-ESC
    
```

The "UNSUPPORTED" message appears.

```

MENU5 (SCREEN CAPTURE)
<CURRENT MEMORY STATUS>
1080i/60
7. USB FILE NO. 1
<MONITOR-USB MEMORY>
8. WRITE TO MEMORY EXECUTE
<USB MEMORY-MONITOR>
9. DOWNLOAD EXECUTE
PROCESSING...
    
```

In case of trouble

The device is detecting to see if the USB memory is inserted.

In normal state

```

MENU5 (SCREEN CAPTURE)
<CURRENT MEMORY STATUS>
1080i/60
7. USB FILE NO. 1
<MONITOR-USB MEMORY>
8. WRITE TO MEMORY EXECUTE
<USB MEMORY-MONITOR>
9. DOWNLOAD EXECUTE
DEVICE USB MEMORY
WRITE TO USB MEMORY?
OK-ENT CANCEL-ESC
    
```

The detection result is displayed here. When the USB memory is recognized, "USB MEMORY" appears onscreen.

When ready to write press the ENT switch. To interrupt it, press the ESC switch.

By pressing the ESC switch at this point, the device is disconnected and the USB memory can be drawn out.

```

MENU5 (SCREEN CAPTURE)
<CURRENT MEMORY STATUS>
1080i/60
7. USB FILE NO. 1
<MONITOR-USB MEMORY>
8. WRITE TO MEMORY EXECUTE
<USB MEMORY-MONITOR>
9. DOWNLOAD EXECUTE
WRITING...
DO NOT REMOVE THE DEVICE!
    
```

During write

```

MENU5 (SCREEN CAPTURE)
<CURRENT MEMORY STATUS>
1080i/60
7. USB FILE NO. 1
<MONITOR-USB MEMORY>
8. WRITE TO MEMORY EXECUTE
<USB MEMORY-MONITOR>
9. DOWNLOAD EXECUTE
JOB COMPLETED!
THE DEVICE CAN BE REMOVED.
EXIT-ESC
    
```

Write complete

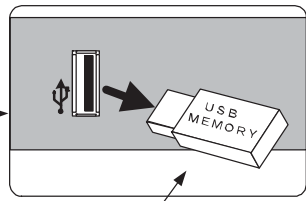

Draw out the USB memory

How to download full capture data from USB memory to monitor

```

MENU5 (SCREEN CAPTURE)
<CURRENT MEMORY STATUS>
1080i/60
7. USB FILE NO 1
<MONITOR-USB MEMORY>
8. WRITE TO MEMORY EXECUTE
<USB MEMORY-MONITOR>
9. DOWNLOAD EXECUTE
SET-ENT EXIT-ESC
    
```

Setting the file number to write in to USB memory. If the broadcast format of the picture to download is different from a picture inputting, it is not displayed during downloading normally.

◆Precaution
Do not draw out the inserted USB memory until the writing has been completed. If drawn out during access, the device may get damaged.
The USB memory use USB memory formatted in FAT12/16/32, VFAT.
The USB cannot use USB memory with the security software.

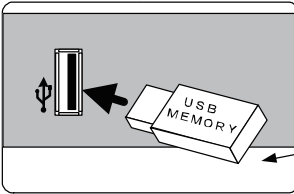

Insert a USB memory into the USB port at the monitor front.

```

MENU5 (SCREEN CAPTURE)
<CURRENT MEMORY STATUS>
1080i/60
7. USB FILE NO 1
<MONITOR-USB MEMORY>
8. WRITE TO MEMORY EXECUTE
<USB MEMORY-MONITOR>
9. DOWNLOAD EXECUTE
SET-ENT EXIT-ESC
    
```

Move the cursor to "EXECUTE" and press the ENT switch.

By pressing the ESC switch at this point, the device is disconnected and the USB memory can be drawn out.

When no USB memory is inserted:

```

MENU5 (SCREEN CAPTURE)
<CURRENT MEMORY STATUS>
1080i/60
7. USB FILE NO 1
<MONITOR-USB MEMORY>
8. WRITE TO MEMORY EXECUTE
<USB MEMORY-MONITOR>
9. DOWNLOAD EXECUTE
DEVICE NO CONNECT
SET USB MEMORY
CANCEL-ESC
    
```

The "NO CONNECT" message appears.

When an unsupported device is inserted:

```

MENU5 (SCREEN CAPTURE)
<CURRENT MEMORY STATUS>
1080i/60
7. USB FILE NO 1
<MONITOR-USB MEMORY>
8. WRITE TO MEMORY EXECUTE
<USB MEMORY-MONITOR>
9. DOWNLOAD EXECUTE
DEVICE UNSUPPORTED
SET USB MEMORY
CANCEL-ESC
    
```

The "UNSUPPORTED" message appears.

```

MENU5 (SCREEN CAPTURE)
<CURRENT MEMORY STATUS>
1080i/60
7. USB FILE NO 1
<MONITOR-USB MEMORY>
8. WRITE TO MEMORY EXECUTE
<USB MEMORY-MONITOR>
9. DOWNLOAD EXECUTE
PROCESSING...
    
```

In case of trouble

The device is detecting to see if the USB memory is inserted.

```

MENU5 (SCREEN CAPTURE)
<CURRENT MEMORY STATUS>
1080i/60
7. USB FILE NO 1
<MONITOR-USB MEMORY>
8. WRITE TO MEMORY EXECUTE
<USB MEMORY-MONITOR>
9. DOWNLOAD EXECUTE
DEVICE USB MEMORY
DOWNLOAD?
OK-ENT CANCEL-ESC
    
```

In normal state

The detection result is displayed here. When the USB memory is recognized, "USB MEMORY" appears onscreen.

When ready to write, press the ENT switch. To interrupt it, press the ESC switch.

By pressing the ESC switch at this point, the device is disconnected and the USB memory can be drawn out.

```

MENU5 (SCREEN CAPTURE)
<CURRENT MEMORY STATUS>
1080i/60
7. USB FILE NO 1
<MONITOR-USB MEMORY>
8. WRITE TO MEMORY EXECUTE
<USB MEMORY-MONITOR>
9. DOWNLOAD EXECUTE
LOADING...
DO NOT REMOVE THE DEVICE
    
```

During download

```

MENU5 (SCREEN CAPTURE)
<CURRENT MEMORY STATUS>
1080i/60
7. USB FILE NO 1
<MONITOR-USB MEMORY>
8. WRITE TO MEMORY EXECUTE
<USB MEMORY-MONITOR>
9. DOWNLOAD EXECUTE
JOB COMPLETED!
THE DEVICE CAN BE REMOVED
EXIT-ESC
    
```

Download completed

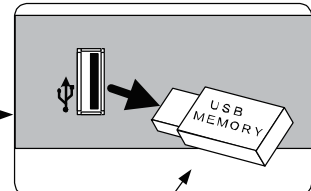

Draw out the USB memory.

4-8. Description of MENU 6 Functions

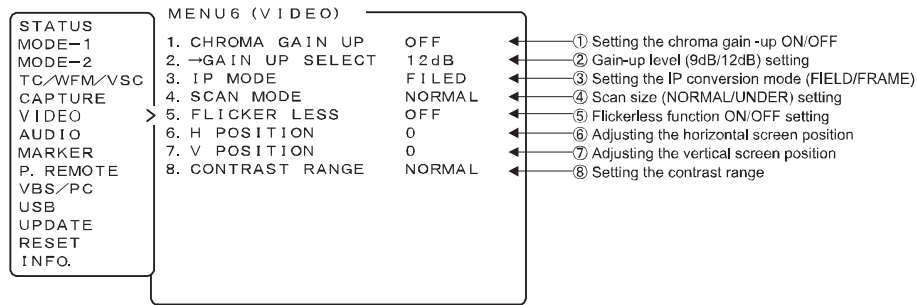

① Setting the chroma gain-up ON/OFF

- Set the gain-up ON/OFF for chroma signals.
- At the time of ON, setting in item ② the chroma gain increases by "+9 dB/+12dB".
- This function can be assigned with the **F1** to **F4** switch on the front panel.
- Default setting is OFF.

② Setting the gain-up level (9dB/12dB)

- Sets the Chroma Gain Up level.
- Selects the Chroma Gain Up level from "+9dB/+12dB".
- Default setting is +12dB.

③ Setting the IP conversion mode

- The mode for I → P conversion is set in the 1035i/1080i/1080psF/480i/575i formats.
- **FRAME** : The information on the previous and subsequent fields is used to convert images to progressive ones. Thanks to this, diagonal interpolation of moving images is enabled for optimum setting.
- **FIELD** : The line interpolation in the field is used to convert images to progressive ones. In this way, the signal delay can be minimized.
- **INTERLACE** : The image transformation process (I/P transformation, scaling) is not performed at all for the interlaced signal (1080i only) like CRT, and black is displayed between the lines similar to the interlaced scan, and then the CRT-like image expression can be achieved.

■ INTERLACE mode display

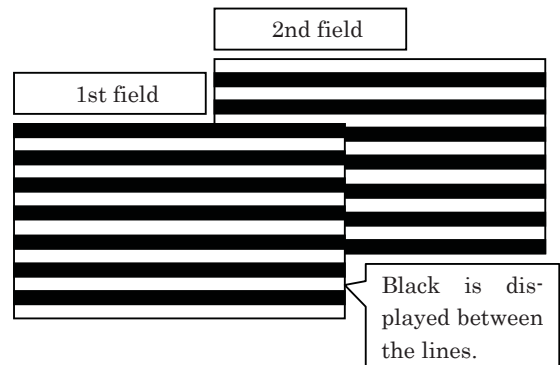

- This function can be assigned with the **F1** to **F4** switch on the front panel.
- * If the delay difference between the image and audio is concerned in the application, you can set to "FIELD, INTERLACE" to operate in a short delay mode, which enables operation almost without discomfort.
- * The image quality of the FIELD mode tends to have some jaggies on the diagonal videos comparing to the FRAME interpolation.
- * In principle, the brightness is reduced due to the black inserts between lines in the INTERLACE mode; thus, it is corrected by increasing the CONTRAST level. However, this may cause the brightness to be close to the MAX brightness, resulting in "OVER RANGE". Therefore, the PRESET brightness is set to 100cd/m2. If the CONTRAST level is increased for the PRESET setting value, it will make the "OVER RANGE" LED easier to light up.
- Default setting is FIELD.

④ **Scan size (NORMAL/UNDER) setting**

- Switches the image display sizes between NORMAL SCAN and UNDER SCAN.

< 16:9NORMAL SCAN > < 16:9UNDER SCAN >

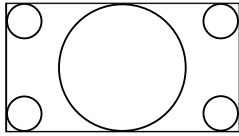

100% display

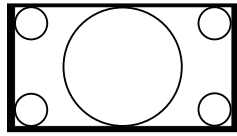

95% of NORMAL SCAN

< 4:3NORMAL SCAN > < 4:3UNDER SCAN >

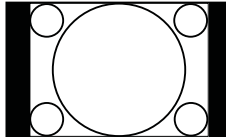

• Default setting is NORMAL.

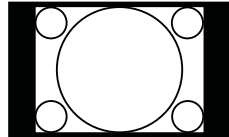

⑤ **Setting the flickerless function ON/OFF**

- When it is used in a PC mode or the still picture is monitored, the flicker can be reduced by turning on the flickerless function to make it double speed display.

* The line may appear double for videos.

- Default setting is OFF.

⑥ **Adjusting the horizontal screen position**

- Adjust the horizontal screen position of VIDEO input (SDI, VBS).
- The settings are memorized for each channel, each format, SYNC INT/EXT.
- * In this setting, the values will not be stored due to the "POWER ON STATUS" function.
- Default setting is 0.

⑦ **Adjusting the vertical screen position**

- Adjust the vertical screen position of VIDEO input (SDI, VBS, COMPONENT).
- The settings are memorized for each channel, each format, SYNC INT/EXT.
- Default setting is 0.

⑧ **Setting the contrast range**

- NORMAL : Set the video level within the range with no over-flow even if the contrast level is MAX.
- WIDE : The contrast level can be increased to two times.
*The high level video has the over-flow.
- Default setting is NORMAL.

4-9. Description of MENU 7 Functions

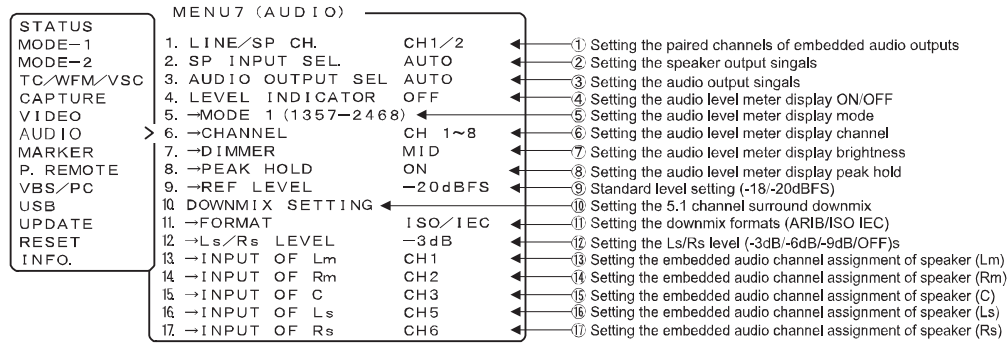

① Setting the channel of embedded audio outputs

- Set any of the following pairs of channels of embedded audio to be outputted to the front speaker, the headphone and the rear audio monitor output.
- CH1/2 : The output comes out of the paired CH1 and CH2 channels.
- CH3/4 : The output comes out of the paired CH3 and CH4 channels.
- CH5/6 : The output comes out of the paired CH5 and CH6 channels.
- CH7/8 : The output comes out of the paired CH7 and CH8 channels.
- DOWNMIX : The output comes out of downmix 5.1ch surround audio.
- This function can be assigned with the **[F1]** to **[F4]** switch on the front panel.
- Default setting is CH1/2.

② Setting the speaker output signals

- Set the signals to be outputted to the speaker, the headphone, and the rear audio monitor output.
- AUTO : embedded audios in the SDI input mode, and analog in the VBS input modes
- EMBEDDED : fixed at embedded audios
- ANALOG : fixed at analog audio
- Default setting is AUTO.

③ Setting the audio output signals

- Sets the signal to be output to the rear audio monitor out.
- AUTO : embedded audios in the SDI input mode, and analog in the VBS input modes
- EMBEDDED : fixed at embedded audios
- ANALOG : fixed at analog audio
- Default setting is AUTO.

④ Setting the audio level meter display ON/OFF

- Used to turn on and off the audio level meter display.
- Default setting is OFF.

⑤ Setting the mode display of audio level meter

- Set the display mode of the audio level meter.
- The number in parentheses shows the order of display channel.
- MODES 5 to 8 are obtained by doubling the width of MODE 1 to 4.

- MODE1 (1357-2468)

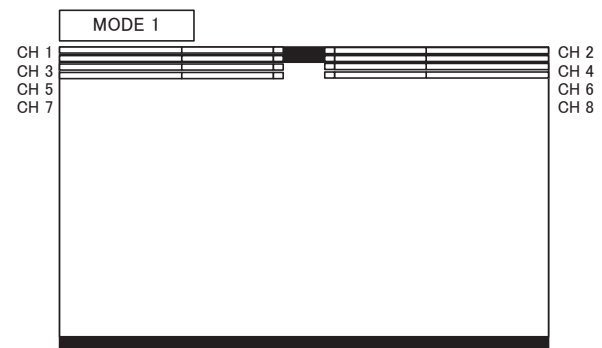

- MODE2 (1234-5678)

MODE3 (1357-8642)

MODE4 (12-34) : During the display mode 1-2ch and 1-4ch settings.

MODE4 (1234-5678) : During the display mode 1-8ch settings.

* The display of MODE 4 varies depending on the number of channels for the section ⑤.

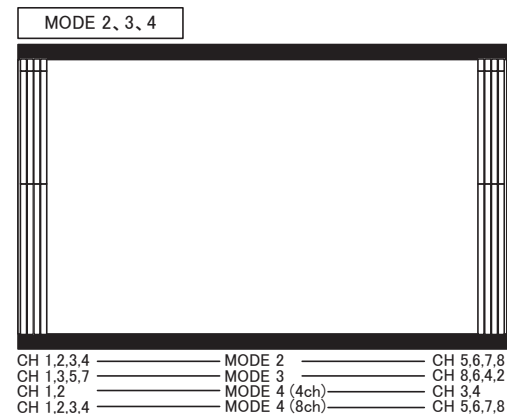

- MODE5 (1357-2468)

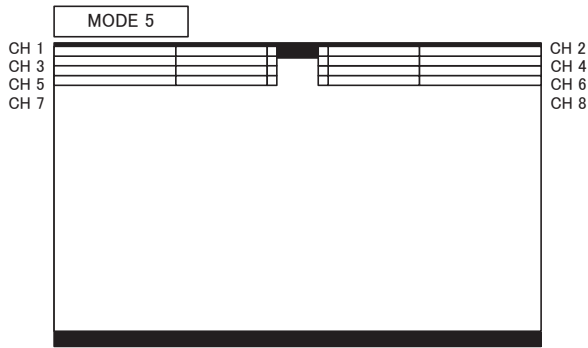

- MODE6 (1234-5678)
- MODE7 (1357-8642)
- MODE8 (12-34) : During the display mode 1-2ch and 1-4ch settings.
- MODE8 (1234-5678) : During the display mode 1-8ch settings.

* The display of MODE 4 varies depending on the number of channels for the section ⑤.

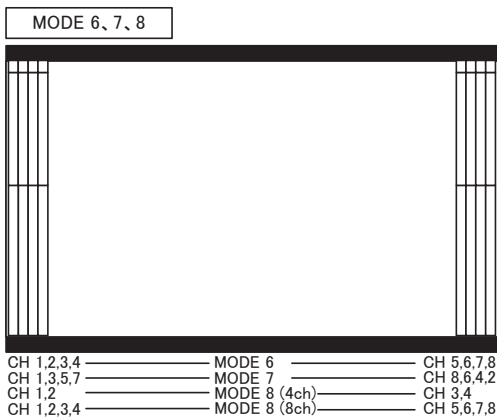

- Default setting is 1(1357-2468).

⑥ Setting the channel display of audio level meter

- Set the display channel of the audio level meter.
 - CH 1-2 : CH1 to CH2 is displayed.
 - CH 1-4 : CH1 to CH4 is displayed.
 - CH 1-8 : CH1 to CH8 is displayed.
- Default setting is CH 1-8.

⑦ Setting the brightness of audio level meter

- Set the brightness of the audio level meter.
- The level meter image transmissive mode or nontransmissive mode can be set.
 - LOW
 - MID
 - HIGH
 - LOW (MIX) (Image transmissive mode)
 - MID (MIX) (Image transmissive mode)
 - HIGH (MIX) (Image transmissive mode)
- Default setting is MID.

⑧ Setting the peak hold display of audio level meter

- Used to turn on and off the peak hold display.
- Default setting is ON.

⑨ Setting the reference level

- Set the reference level of the audio level meter.
 - -18dBFS
 - -20dBFS
- Default setting is -20dBFS

⑩ Downmix setting

- Set the 5.1 channel surround downmix.
- Mix the 5.1 channel surround audio signal assigned to 6 channels of embedded audio into 2 channels and outputs from the speaker, the headphone and the audio monitor output.
- 5.1ch surround super woofer(LFE) channel is not mixed.

⑪ Setting the downmix formats

- Select the mixing method to downmix 5.1ch audio in “ISO/IEC” and “ARIB”.
- Default setting is ISO/IEC

⑫ Setting the Ls/Rs level

- Set the coefficient of Ls/Rs to mix.
- Set among -3dB/-6dB/-9dB/OFF. (OFF = $-\infty$)
- Default setting is -3dB

⑬ Setting the embedded audio channel assignment of speaker (Lm)

- Set the channel of embedded audio, which the audio for 5.1ch surround Lm speaker (left side in front) should be assigned from.
- Default setting is CH1

⑭ Setting the embedded audio channel assignment of speaker (Rm)

- Set the channel of embedded audio, which the audio for 5.1ch surround Rm speaker (right side in front) should be assigned from.
- Default setting is CH2

⑮ Setting the embedded audio channel assignment of speaker (C)

- Set the channel of embedded audio, which the audio for 5.1ch surround C speaker (center) should be assigned from.
- Default setting is CH3

⑯ Setting the embedded audio channel assignment of speaker (Ls)

- Set the channel of embedded audio, which the audio for 5.1ch surround Ls speaker (left side in rear) should be assigned from.
- Default setting is CH5

⑪ **Setting the embedded audio channel assignment of speaker (Rs)**



- Set the channel of embedded audio, which the audio for 5.1ch surround Rs speaker (right side in rear) should be assigned from.
- Default setting is CH6

4-10. Description of MENU 8 Functions

| STATUS | MENU 8 (MARKER) | SAFETY | |
|------------|---------------------|---------|--|
| MODE-1 | 1. MARKER (16:9) | SAFETY | ① Setting the type of marker displayed at 16:9 aspect ratio |
| MODE-2 | 2. -SAFETY AREA | 80% | ② Setting the 16:9 safety marker area (80-99% (1% increments)) |
| TC/WFM/VSC | 3. -ASPECT | 4:3 | ③ Setting the type of aspect marker at 16:9 display |
| CAPTURE | 4. -AREA IN ASPECT | 80% | ④ Setting the safety marker (80-99% (1% increments)) in aspect marker area |
| VIDEO | 5. MARKER (4:3) | SAFETY | ⑤ Setting the type of marker displayed at 4:3 aspect ratio |
| AUDIO | 6. -SAFETY AREA | 80% | ⑥ Setting the 4:3 safety marker (80-99% (1% increments)) |
| MARKER | 7. -ASPECT | 16:9 | ⑦ Setting the type of aspect marker at 4:3 display |
| P. REMOTE | 8. ASP. MARKER MODE | MRK+SHD | ⑧ Setting the aspect marker display mode |
| VBS/PC | 9. -SHADOW LEVEL | 40% | ⑨ Setting the shadow contrast level with shadow on screen |
| USB | 10. CENTER MARKER | OFF | ⑩ Setting the center cross marker ON/OFF |
| UPDATE | 11. MARKER LEVEL | 60% | ⑪ Setting the marker display level |
| RESET | 12. MARKER COLOR | □ | ⑫ Setting the marker display color |
| INFO. | 13. USER MARKER | ON | ⑬ Setting the user marker display ON/OFF |
| | 14. -SCENE NAME | SCENE 1 | ⑭ Selecting each scene of user markers and setting the scene names. |
| | 15. -SETTING | EXECUTE | ⑮ Executing the user marker for the drawing setting menu |

① Setting the type of marker (at 16:9 aspect ratio)

- Used to set various types of markers displayed at 16:9 aspect ratio.
- SAFETY** : Displaying the safety marker preset in Item ② .
- ASPECT** : Displaying the aspect marker preset in Item ③ .
- ASP+SAF** : Displaying the aspect marker preset in Item ③ and the safety marker in aspect marker area preset in Item ④ .
- C.CROSS** : Cross marker.
- CROSS5** : 5-split crosshatch pattern.
- CROSS10** : 10-split crosshatch pattern.
- This function can be assigned with the **F1** to **F4** switch on the front panel.

The types of markers can also be set with the  and  switches on the front panel with no menu displayed.

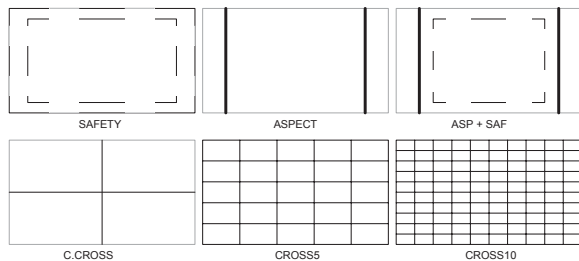

- Default setting is **SAFETY**.

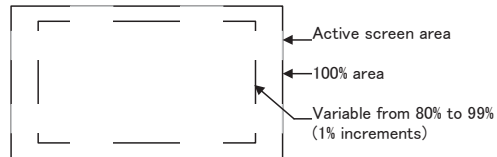

② Setting the safety marker area (at 16:9 aspect ratio)

- Used to set the safety marker area in the 80%- 99% range with 1% increments at 16:9 aspect ratio.



Somewhere between 80% and 99% can also be set with the  and  switches on the front panel with no menu displayed.

- Default setting is 80% (safety area).

③ Setting the type of aspect marker (at 16:9 aspect ratio)

- Used to select the type of aspect marker from “4:3, 13:9, 14:9, 15:9, 1.85:1 and 2.35:1” at 16:9 aspect ratio.

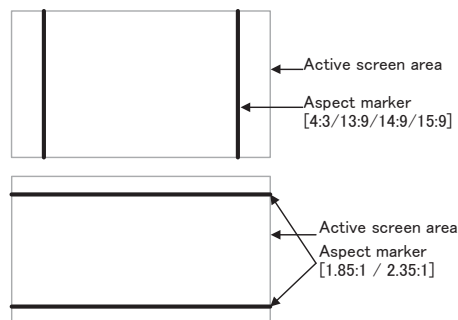

- Default setting is 4:3 marker.

④ Setting the safety marker area in aspect marker area (at 16:9)

- Used to set the safety marker in the aspect marker (4:3, 13:9, 14:9 and 15:9) area in the 80%-99% range with 1% increments at 16:9 aspect ratio.

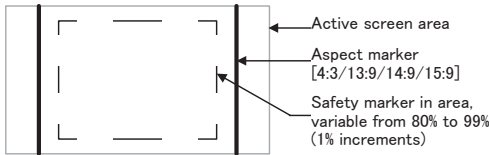

- Somewhere between 80% and 99% can also be set with the ▲ and ▼ switches on the front panel with no menu displayed.

• Default setting is 80% (safety area).

⑤ Setting the type of marker (at 4:3 aspect ratio)

- Used to set various types of markers displayed at 4:3 aspect ratio.
- SAFETY** : Displaying the safety marker preset in Item ④.
- ASPECT** : Displaying the aspect marker preset in Item ⑦.
- C.CROSS** : Cross marker.
- CROSS5** : 5-split crosshatch pattern.
- CROSS10** : 10-split crosshatch pattern.
- This function can be assigned with the F1 to F4 switch on the front panel.

- The types of markers can also be set with the ◀ and ▶ switches on the front panel with no menu displayed.

• Default setting is SAFETY.

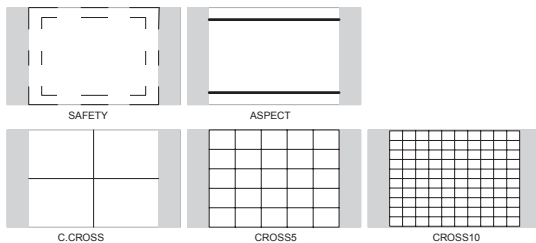

⑥ Setting the safety marker area (at 4:3 aspect ratio)

- Used to set the safety marker area in the 80%-99% range with 1% increments at 4:3 aspect ratio.

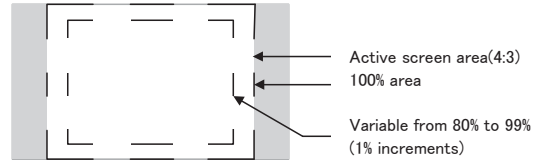

- Somewhere between 80% and 99% can also be set with the ▲ and ▼ switches on the front panel with no menu displayed.

• Default setting is 80% (safety area).

⑦ Setting the type of aspect marker (at 4:3 aspect ratio)

- Used to select the type of aspect marker from "13:9, 14:9, 15:9 and 16:9" at 4:3 aspect ratio.

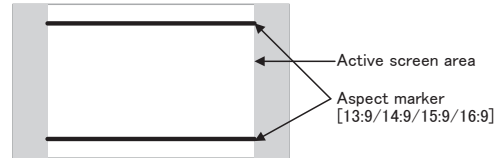

• Default setting is 16:9 marker.

⑧ Setting the aspect marker display mode

- Used to set the aspect marker display mode.
- MARKER** : Displaying the marker only.
- SHADOW** : Displaying the shadow only.
- MRK+SHD** : Displaying both the marker and shadow.

• Default setting is MARKER+SHADOW.

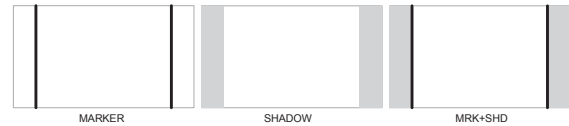

⑨ Setting the aspect marker shadow level

- Used to set the contrast level of the aspect marker shadow, when displayed.
- Settings: 0%, 20%, 40% and 60%
- Default setting is 40%.

⑩ Setting the center cross marker ON/OFF

- Used to turn on and off the center cross marker.
- Default setting is OFF.

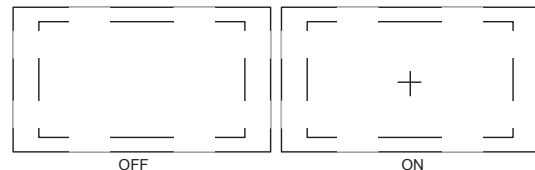

⑪ Setting the marker display level

- Used to set the marker display level.
- Settings: 20%, 40%, 60%, 80% and 100%
- Default setting is 60%.

⑫ Setting the marker display color

- Used to set the marker display color.
- * The user marker is displayed in the color pre-set on the user marker menu.
- Settings : White, yellow, cyan, green, magenta, red and blue
- Default setting is white.

⑬ Setting the user marker display ON/OFF

- Used to turn on and off the user marker display.
- This function can be assigned with the **F1** to **F4** switch on the front panel.
- Default setting is OFF.

⑭ Selecting each scene of user markers and setting the scene names

- The user markers can be set for up to 10 scenes; you can select from displays of SCENE 1 to SCENE 10.

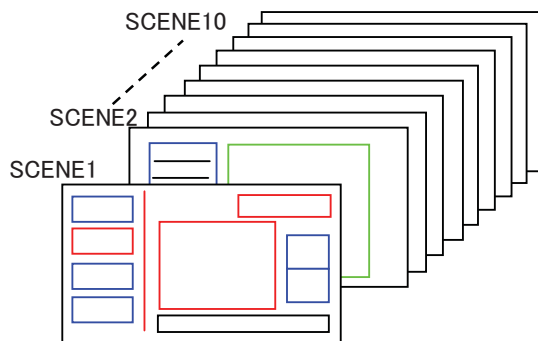

- The name of each scene can be up to 8 characters in length with the following characters: "0-9, A-Z, 0, -, □ (blank)".
- If you press ENT on the SCENE, the following SETTING MENU is displayed, and there you can change the name of each SCENE.

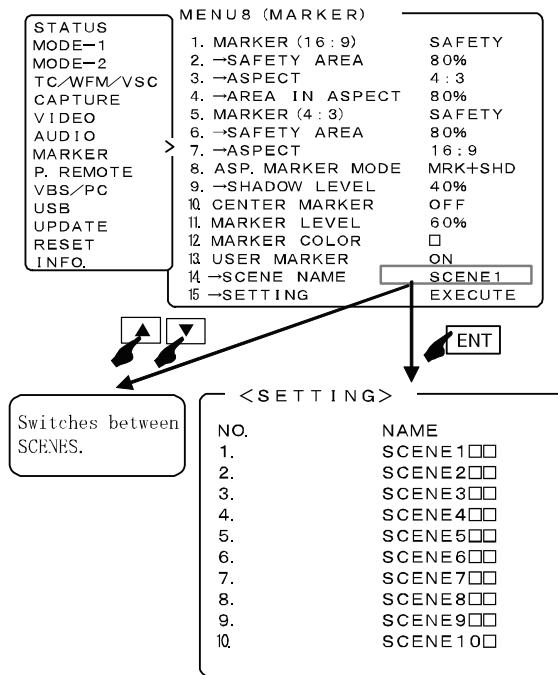

- The switching of the scenes can be assigned to the **F1** to **F4** switches on the previous screen.
- Default setting is SCENE1.

⑮ Executing the user marker for the drawing setting menu

- Press **ENT** with EXECUTE, and the user markersetting menu shows up. Now various settings can be made on this menu.
- For details, refer to Item 4-11.

4-11. Description of MENU8-15 (USER MARKER) Functions and Making Settings

<PAGE 1 >

②NO ③COL ④SW ①SCENE NAME ⑤DATA(X,Y)

<SETTING OF USER MARKER>

PAGE1

SCENE NAME : SCENE1

| NO. | COL | SW | DATA (X Y) |
|-----|--------------------------|----|----------------------|
| MK1 | <input type="checkbox"/> | ON | S: _____ E: _____ |
| MK2 | <input type="checkbox"/> | ON | S: _____ E: _____ |
| MK3 | <input type="checkbox"/> | ON | S: _____ E: _____ |
| MK4 | <input type="checkbox"/> | ON | S: _____ E: _____ |
| MK5 | <input type="checkbox"/> | ON | S: _____ E: _____ |

↓ (NEXT PAGE)

SET → [ENT] EXIT → [ESC]

<PAGE 2 >

<SETTING OF USER MARKER>

PAGE2

| NO. | COL | SW | DATA (X Y) |
|----------|--------------------------|----|----------------------|
| ↑ (BACK) | | | |
| MK6 | <input type="checkbox"/> | ON | S: _____ E: _____ |
| MK7 | <input type="checkbox"/> | ON | S: _____ E: _____ |
| MK8 | <input type="checkbox"/> | ON | S: _____ E: _____ |
| MK9 | <input type="checkbox"/> | ON | S: _____ E: _____ |
| MK10 | <input type="checkbox"/> | ON | S: _____ E: _____ |

SET → [ENT] EXIT → [ESC]

① The scene name for user marker

② Types of user markers

③ Setting the user marker color

④ Setting the user marker display ON/OFF

⑤ User marker coordinates

◆ How to turn from PAGE1 to PAGE2

When the blinking cursor is at MK1, use the switch to go to PAGE2. With the blinking cursor at MK5, use the switch to go to PAGE2.

③ The scene name for user marker

- The scene name of the user marker to be set is displayed, and you can use switch to change the scene.

② Types of user markers

- The user markers are presettable in boxes or lines, chosen from 10 types from MK1 to MK10. Up to 10 different display positions of subtitles can therefore be individually preset, depending on programs. Use the and switches to select a desired item.

<10 different display examples>

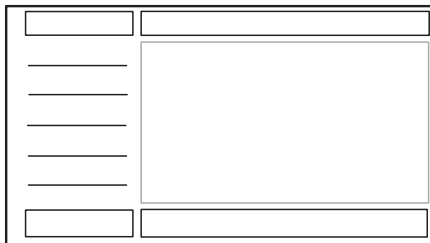

③ Setting the user marker color

- Using the “COL” item, select a desired display color from 6 colors. The 10 types of user markers can be color-coded to identify them if two or more user markers are used.
- Settings : White, yellow, cyan, green, red and blue
- Default setting is white.

④ Setting the user marker display ON/OFF

- Using the “SW” item, the display can be turned on and off.
- Default setting is ON.

⑤ **User marker coordinates**

- In the “DATA (X Y)” column, the coordinates for **[S : START POINT]** and **[E : END POINT]** of the currently set user markers are displayed. without such settings, the “-” marker appears.
- Move the cursor to the X/Y data. Using the **[ENT]** switch, new user markers can be drawn or already registered user markers can be modified.
- The setting can be made in 1-pixel increments. The top left of the effective screen serves as the reference point (0001, 0001) of the coordinates. From this point, the coordinates can be adjusted in the pixel range of 1920 x 1080.
- Default setting is -(unregistered).

● **Resetting the data**

- With the “DATA (X Y)” settings blinking in magenta, hold down the **[▶]** switch (or the right-hand button on the mouse) longer than 3 seconds, and the preset data may be deleted (-).

● **Coordinate reference point**

This 1920 x 1080, Full-HD panel has the pixel reference point (0001, 0001) at the top left of the screen. The pixel at the bottom right on screen is preset as the coordinates (1920, 1080).

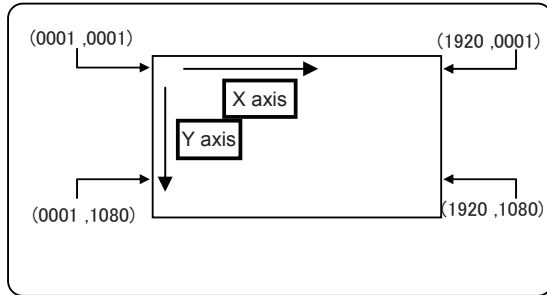

● **Marker lines and coordinate values**

There are 2 line widths for the user markers. However, the coordinate for the start point and that for the end point are different by 1 pixel.

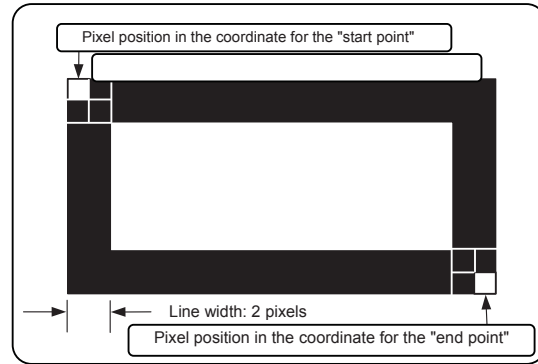

Accordingly, in drawing a horizontal line, the Y-direction address has a coordinate value with 1 pixel added, as shown below.

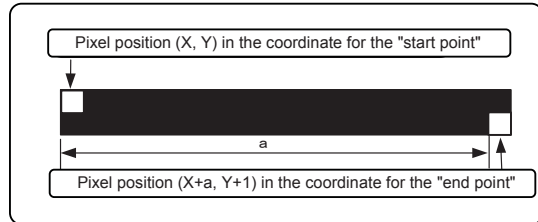

When a vertical line is drawn, the X-axis address has a coordinate value with 1 pixel added, as shown below.

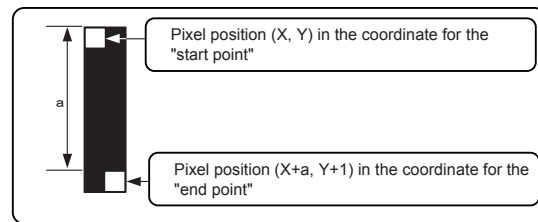

How to preset new user markers

① Setting the marker display ON/OFF

| MENU 8 (MARKER) | |
|---------------------|-------------------------------------|
| 1. MARKER (16:9) | SAFETY |
| 2. -SAFETY AREA | 80% |
| 3. -ASPECT | 4:3 |
| 4. -AREA IN ASPECT | 80% |
| 5. MARKER (4:3) | SAFETY |
| 6. -SAFETY AREA | 80% |
| 7. -ASPECT | 16:9 |
| 8. ASP. MARKER MODE | MRK+SHD |
| 9. -SHADOW LEVEL | 40% |
| 10. CENTER MARKER | OFF |
| 11. MARKER LEVEL | 60% |
| 12. MARKER COLOR | <input type="checkbox"/> |
| 13. USER MARKER | <input checked="" type="checkbox"/> |
| 14. -SCENE NAME | SCENE1 |
| 15. -SETTING | EXECUTE |

Set USER MARKER to ON.

Move the cursor

② Execute the drawing mode in item 14

| MENU 8 (MARKER) | |
|---------------------|-------------------------------------|
| 1. MARKER (16:9) | SAFETY |
| 2. -SAFETY AREA | 80% |
| 3. -ASPECT | 4:3 |
| 4. -AREA IN ASPECT | 80% |
| 5. MARKER (4:3) | SAFETY |
| 6. -SAFETY AREA | 80% |
| 7. -ASPECT | 16:9 |
| 8. ASP. MARKER MODE | MRK+SHD |
| 9. -SHADOW LEVEL | 40% |
| 10. CENTER MARKER | OFF |
| 11. MARKER LEVEL | 60% |
| 12. MARKER COLOR | <input type="checkbox"/> |
| 13. USER MARKER | <input checked="" type="checkbox"/> |
| 14. -SCENE NAME | SCENE1 |
| 15. -SETTING | EXECUTE |

Press **ENT** now.

③ Setting the individual markers

| <SETTING OF USER MARKER> | | | |
|--------------------------|--------------------------|----|--|
| PAGE1 | | | |
| SCENE NAME : SCENE1 | | | |
| NO. | COL | SW | DATA (X Y) |
| MK1 | <input type="checkbox"/> | ON | S: : : : : : E: : : : : : : : : : : : : : : : : : E: : : : : : S: : : : : : E: : : : : : |
| MK2 | <input type="checkbox"/> | ON | S: : : : : : E: : : : : : : : : : : : : : : : : : E: : : : : : S: : : : : : E: : : : : : |
| MK3 | <input type="checkbox"/> | ON | S: : : : : : E: : : : : : : : : : : : : : : : : : E: : : : : : S: : : : : : E: : : : : : |
| MK4 | <input type="checkbox"/> | ON | S: : : : : : E: : : : : : : : : : : : : : : : : : E: : : : : : S: : : : : : E: : : : : : |
| MK5 | <input type="checkbox"/> | ON | S: : : : : : E: : : : : : : : : : : : : : : : : : E: : : : : : S: : : : : : E: : : : : : |
| I (NEXT PAGE) | | | |

Set the color and ON/OFF display for individual markers.

④ Going to the drawing menu

| <SETTING OF USER MARKER> | | | |
|--------------------------|--------------------------|----|--|
| PAGE1 | | | |
| SCENE NAME : SCENE1 | | | |
| NO. | COL | SW | DATA (X Y) |
| MK1 | <input type="checkbox"/> | ON | S: : : : : : E: : : : : : : : : : : : : : : : : : E: : : : : : S: : : : : : E: : : : : : |
| MK2 | <input type="checkbox"/> | ON | S: : : : : : E: : : : : : : : : : : : : : : : : : E: : : : ~ : S: : : : ~ : E: : : : ~ : |
| MK3 | <input type="checkbox"/> | ON | S: : : : ~ : E: : : : ~ : : : : : ~ : : : : : ~ : E: : : : ~ : S: : : : ~ : E: : : : ~ : |
| MK4 | <input type="checkbox"/> | ON | S: : : : ~ : E: : : : ~ : : : : : ~ : : : : : ~ : E: : : : ~ : S: : : : ~ : E: : : : ~ : |
| MK5 | <input type="checkbox"/> | ON | S: : : : ~ : E: : : : ~ : : : : : ~ : : : : : ~ : E: : : : ~ : S: : : : ~ : E: : : : ~ : |
| I (NEXT PAGE) | | | |

The menu screen in Step ③ reappears and the settings are displayed at the X-Y coordinate.

⑤ Setting the start point

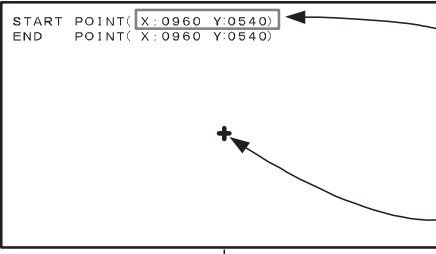

With nothing registered, the initial X-Y coordinate is displayed, and the start-point X-Y coordinate starts blinking.

With nothing registered, the cursor is displayed at the default center.

⑥ Moving the cursor to the start point

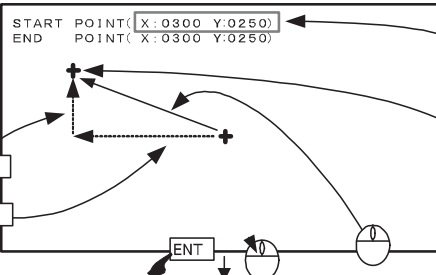

The shifted X-Y coordinate is displayed.

Move the cursor to the start point.

⑦ Saving the start point

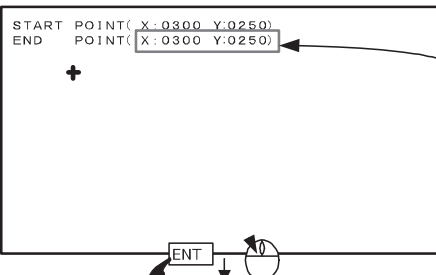

The end-point X-Y coordinate starts blinking.

⑧ Moving the cursor to the end point

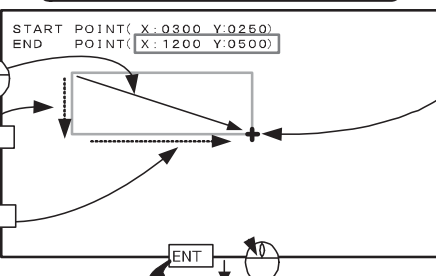

Move the cursor to the end point.

Take the procedure to set a new start point

⑨ Saving the end point

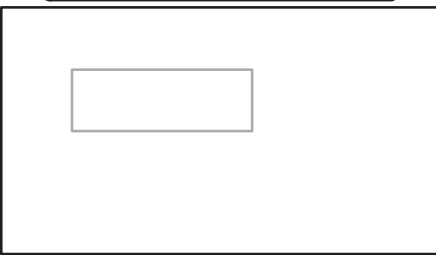

The cursor moves to the start point. Take the procedure in Step ⑤ on the next page.

How to modify the user markers

① Setting the marker display ON/OFF

| MENU 8 (MARKER) | | |
|---------------------|---------|--------|
| 1. MARKER (16:9) | | SAFETY |
| 2. →SAFETY AREA | 80% | |
| 3. →ASPECT | 4:3 | |
| 4. →AREA IN ASPECT | 80% | |
| 5. MARKER (4:3) | | SAFETY |
| 6. →SAFETY AREA | 80% | |
| 7. →ASPECT | 16:9 | |
| 8. ASP. MARKER MODE | MRK+SHD | |
| 9. →SHADOW LEVEL | 40% | |
| 10. CENTER MARKER | OFF | |
| 11. MARKER LEVEL | 60% | |
| 12. MARKER COLOR | □ | |
| 13. USER MARKER | □ | ON |
| 14. →SCENE NAME | SCENE1 | |
| 15. →SETTING | EXECUTE | |

Set USER MARKER to ON.

Move the cursor to the start point.

Move the cursor

② Execute the drawing mode in item 14

| MENU 8 (MARKER) | | |
|---------------------|---------|---------|
| 1. MARKER (16:9) | | SAFETY |
| 2. →SAFETY AREA | 80% | |
| 3. →ASPECT | 4:3 | |
| 4. →AREA IN ASPECT | 80% | |
| 5. MARKER (4:3) | | SAFETY |
| 6. →SAFETY AREA | 80% | |
| 7. →ASPECT | 16:9 | |
| 8. ASP. MARKER MODE | MRK+SHD | |
| 9. →SHADOW LEVEL | 40% | |
| 10. CENTER MARKER | OFF | |
| 11. MARKER LEVEL | 60% | |
| 12. MARKER COLOR | □ | |
| 13. USER MARKER | ON | |
| 14. →SCENE NAME | SCENE1 | EXECUTE |
| 15. →SETTING | | |

Press [ENT] now.

③ Setting the individual markers

| <SETTING OF USER MARKER> | | | |
|--------------------------|------------|------------|--------------|
| PAGE1 | SCENE NAME | DATA (X Y) | |
| | SCENE1 | | |
| NO. | COL | SW | |
| MK1 | ■ | ON | S: 0300 0250 |
| | | | E: 1200 0500 |
| MK2 | □ | ON | S: ----- |
| | | | E: ----- |
| MK3 | □ | ON | S: ----- |
| | | | E: ----- |
| MK4 | □ | ON | S: ----- |
| | | | E: ----- |
| MK5 | □ | ON | S: ----- |
| | | | E: ----- |

Set the color and ON/OFF display for individual markers.

④ Setting the modified size

| <SETTING OF USER MARKER> | | | |
|--------------------------|------------|------------|--------------|
| PAGE1 | SCENE NAME | DATA (X Y) | |
| | SCENE1 | | |
| NO. | COL | SW | |
| MK1 | □ | ON | S: 0300 0250 |
| | | | E: 1200 0500 |
| MK2 | □ | ON | S: ----- |
| | | | E: ----- |
| MK3 | □ | ON | S: ----- |
| | | | E: ----- |
| MK4 | □ | ON | S: ----- |
| | | | E: ----- |
| MK5 | □ | ON | S: ----- |
| | | | E: ----- |

The menu screen in Step ③ reappears and the new settings are displayed at the X-Y coordinate.

(Hold down)

Hold down the [] switch (or the right-hand button on the mouse), and the data will be initialized (→).

⑤ Setting a new start point

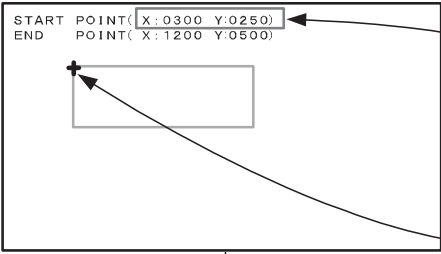

The start-point X-Y coordinate starts blinking.

The magenta-colored cursor appears at the start point.
*If the end point is positioned above or to the left of the start point, the cursor display position depends on the registered data.

⑥ Modifying the start point

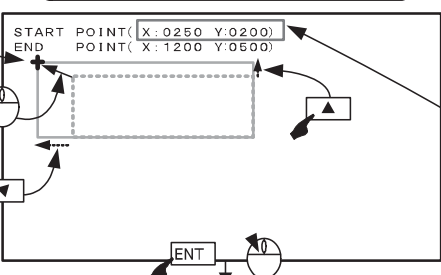

The shifted X-Y coordinate is displayed.

⑦ Modifying the end point

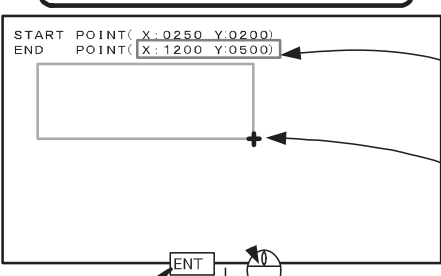

The end-point X-Y coordinate starts blinking.

The magenta-colored cursor appears at the end point.

⑧ Shifting the end point

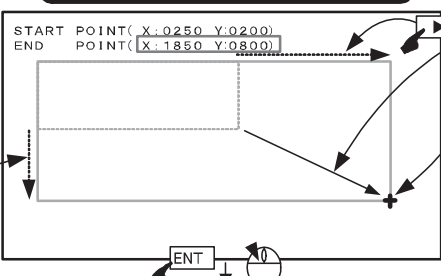

Move the cursor to the end point.

Take the procedure to set a new start point.

⑨ Saving the end point

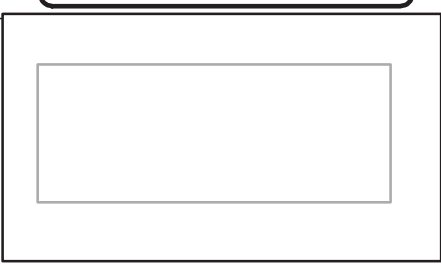

The cursor moves to the start point.

4-12. Description of MENU 9 Functions

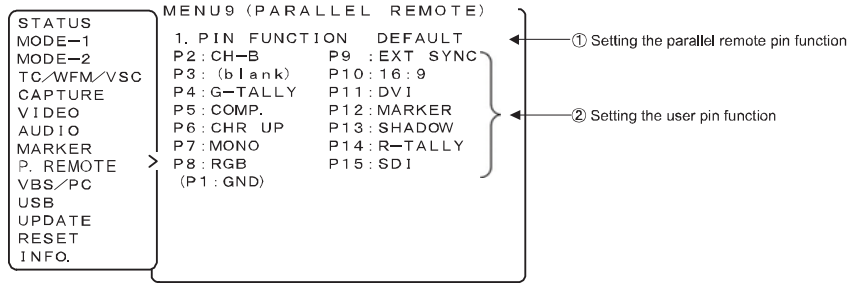

① Setting the functions of parallel remote pins

- Select the pre-assigned pin functions of parallel remote control or the individual user-set functions.
- * By default, the pre-assigned pin functions are displayed beneath.

② Setting the IP conversion mode

- When “USER” is selected in ①, set the individual pin functions. The settable functions are as follows.
 - CH-B : selection of CH-B
 - SDI : selection of SDI input
 - DVI : selection of DVI input
 - COMP. : selection of component input
 - MONO : selection of MONO
 - RGB : selection of component RGB input
 - 16:9 : selection of SDTV aspect ratio 16:9
 - EXT SYNC : selection of external sync input
 - MARKER : marker ON
 - SHADOW : shadow ON at **MENU7**-preset level
 - SHADOW0 : shadow ON at shadow level 0% (Black)
 - SHADOW20 : shadow ON at shadow level 20%
 - SHADOW40 : shadow ON at shadow level 40%
 - SHADOW60 : shadow ON at shadow level 60%
 - R-TALLY : R tally ON
 - G-TALLY : G tally ON
 - 3G-SDI : selection of 3G-SDI input
 - ANALOG PC : selection of Analog PC input
 - CHR UP : CHROMA UP ON
 - UMARK* : USER MARKER SCENE* ON
 - (blank) : unassigned

- * “SHADOW0”, “SHADOW20”, “SHADOW40” and “SHADOW60” functions
- Select two or more SHADOW settings at once, and “SHADOW0” (Black) is given priority.
- When any of these functions is turned ON, the **MENU7**-adjusted shadow level is forced to go back to the level remotely preset.
- * The functions of the following pins, which are fixed, cannot be changed.
 - Pin 1 : Make contact GND

4-13. Description of MENU 10 Functions

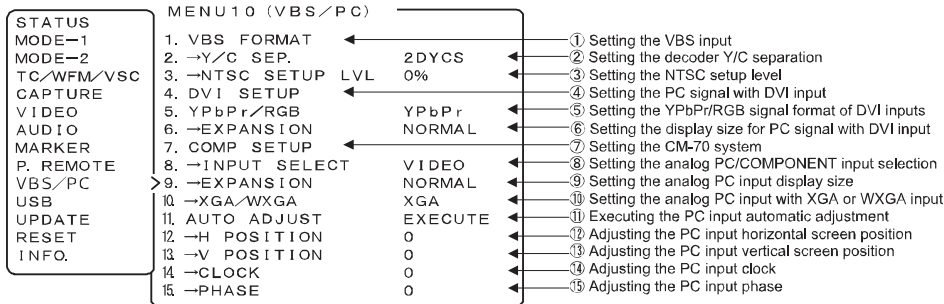

* The settings of the sections 7 to 10 and the sections 14 to 15 are enabled when the optional CM-70 is mounted.

* If the resolution is set to WXGA/SXGA/UXGA/WUXGA in your PC, the refresh rate must be 60Hz.

① Setting the VBS input

- The settings for the VBS signal are set here.

② Setting the decoder Y/C separation

- For the Y/C separation of VBS (composite) signals, set any of the following three types of formats.
 - 2DYCS : two-dimensional comb filter
 - 3DYCS : three-dimensional comb filter
 - TRAP : trap filter
- This function can be assigned with the **[F1]** to **[F4]** switch on the front panel.
- Default setting is 2DYCS.

③ Setting the NTSC setup level

- Used to set the setup level at the time of NTSC signal input. When the black level of the signal has 7.5% setup, it is set to "7.5%".
- Default setting is 0%.

④ Setting the PC signal with DVI inputs

- Used to set the DVI input signal.

⑤ Setting the YPbPr/RGB signal format of DVI inputs

- Used to set the DVI input signal format to YPbPr or RGB.
- Default setting is YPbPr.

⑥ Setting the display size for PC signal with DVI input

- Used to preset the image display size in receiving the PC-format DVI signals.

- This is effective when a DVI input mode has been selected and the related signal is detected.

- REAL : Images are displayed 1 : 1 with the resolution of input signal.
- NORMAL : With the aspect ratio intact, images are enlarged or reduced in this panel's maximum displayable size.
- FULL : Images are fully displayed on-screen (1920 x 1080) for all input signals.

- Default setting is NORMAL.

◆ Display pixels with respect to PC input signals in each mode

| PC input signal (pixels, aspect ratio) | Pixel size and aspect ratio | | |
|---|-----------------------------|----------------------|---------------------|
| | REAL | NORMAL | FULL |
| VGA (640×480, 4:3) | 640×480 (4:3) | 1440×1080 (4:3) | 1920×1080 (16:9) |
| SVGA (800×600, 4:3) | 800×600 (4:3) | 1440×1080 (4:3) | 1920×1080 (16:9) |
| XGA (1024×768, 4:3) | 1024×768 (4:3) | 1440×1080 (4:3) | 1920×1080 (16:9) |
| WXGA (1280×768, 15:9) | 1280×768 (15:9) | 1800×1080 (15:9) | 1920×1080 (16:9) |
| SXGA (1280×1024, 5:4) | 1280×1024 (5:4) | 1350×1080 (5:4) | 1920×1080 (16:9) |
| UXGA (1600×1200, 4:3) | 1600×1200 (4:3) ※1 | 1440×1080 (4:3) | 1920×1080 (16:9) |
| WUXGA (1920×1200, 16:10) | 1920×1200 (16:10) ※1 | 1728×1080 (16:10) | 1920×1080 (16:9) |

*1: In the REAL display mode with UXGA/WUXGA signals, the input signal's number of vertical pixels (1200 pixels) is greater than the display panel's number of corresponding pixels (1080 pixel). As shown below, therefore, the 120-pixel images are cut off on screen at the top and bottom.

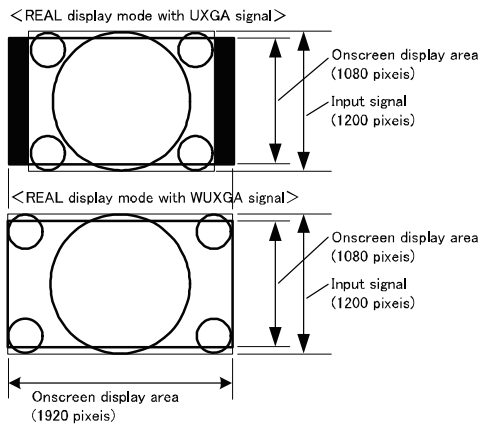

⑦ Setting the CM-70 system

- The settings of optional YPbPr/RGB analog component modules are set here.
- The display is active only when this module is mounted.

⑧ Switching between analog PC and COMPONENT input signals (Settings only for the CM-70)

- PC : Analog PC input of the CM-70 is selected.
- VIDEO : COMPONENT input of the CM-70 is selected.
- This function can be assigned with the **F1** to **F4** switch on the front panel.
- Default setting is VIDEO.

⑨ Setting the display mode with analog PC input (Settings only for the CM-70)

- Used to preset the image display size. The table below Item ① is also applicable with the display pixel size with respect to the input signal mode.
- REAL : Images are displayed with the resolution of input signal.
- NORMAL : With the aspect ratio intact, images are enlarged or reduced in this panel's maximum displayable size.
- FULL : Images are fully displayed onscreen (1920 x 1080).
- Default setting is NORMAL.

⑩ Selecting the analog PC input XGA/WXGA (Settings only for the CM-70)

- When the analog PC input signal is WXGA, the format may fail to be identified, depending on the signal timing. In such case, select WXGA.
- Default setting is XGA.

⑪ Executing the automatic adjustment of PC input (Only for the DVI(PC) and CM-70)

- Used to automatically adjust the phase, clock and horizontal/vertical onscreen position in Items ⑫ thru ⑮.
- With the "EXECUTE" characters blinking, press the **ENT** switch, and the automatic adjustment will be made.
- During the automatic adjustment, do not turn off the power and switch the input signal.

⑫ Adjusting the horizontal onscreen position with PC input (Only for the DVI(PC) and CM-70)

- Used to adjust the horizontal onscreen position.

⑬ Adjusting the vertical onscreen position with PC input (Only for the DVI(PC) and CM-70)

- Used to adjust the vertical onscreen position.

⑭ Adjusting the clock with analog PC input (Settings only for the CM-70)

- Used to adjust if noticeable vertical stripes appear onscreen.

⑮ Adjusting the phase with analog PC input (Settings only for the CM-70)

- Used to adjust if horizontal stripes appear or the characters look blurry onscreen.

4-14. Description of MENU 11 Functions

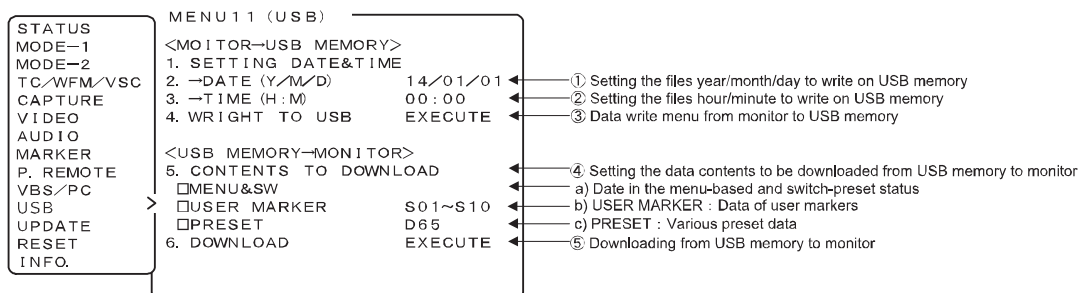

Writing from monitor to USB memory

① Setting the date of a file to be written on USB memory

- Used to set the editing date of a file to be written on a USB memory. Enter a date when you are going to write on the USB memory. When re-viewing files on a computer, the date entered here will be displayed as the date of the file.
- Enter “Y (year)/M (month)/D (day)” in this order.
- If no date is entered, the file will be edited as of the date appearing currently on the menu.

② Setting the time of a file to be written on USB memory

- Used to set the editing time of a file in a way similar to Item ①.
- Enter “H (hour) : M (minute)” in this order. If no time is entered, the file will be edited as of the time appearing currently on the menu.

③ Writing to USB memory

- To write all the setting data from the monitor to a USB memory, select “EXECUTE” and press the **ENT** switch. For writing details, refer to “How to write from monitor to USB memory”.

File format for writing to USB memory

Files to be written from the monitor to a USB memory are created in the following 3 text files in the Ikegami Monitor folder that is automatically prepared.

Ikegami_Monitor : Automatically prepared folders

menu_sw_hem1770_001.txt (for HEM-1770WR)
menu_sw_hem2570_001.txt (for HEM-2570W)

- File to save the menu (USER MARKER and PRESET MENU not included) status and the switch settings.
- Data capacity: Approx. 3 Kbyte
- This file is specific for the HEM-1770WR and HEM-2570W. The PRESET data of the HEM-1770WR, HEM-2570W and other models cannot be downloaded.

user_marker_001.txt (for SCENE1)
user_marker_002.txt (for SCENE2)
.
.
user_marker_010.txt (for SCENE10)

- File to save various setting data of the user markers that are preset in MENU8.
- Data capacity: Approx. 2 Kbyte
- Files common for the full HD models.

preset_hem1770_001.txt (for HEM-1770WR)
preset_hem2570_001.txt (for HEM-2570W)

- File to save the PRESET menu settings as well as all the D65, D93 and FILE1 thru -8 data. The password lock and the password itself are not saved, however.
- Data capacity: Approx. 3 Kbyte
- This file is specific for the HEM-1770WR and HEM-2570W. The PRESET data of the HEM-1770WR, HEM-2570W and other models cannot be downloaded.

◆Precautions on writing

- With a USB connected to the monitor, do not turn ON/OFF the monitor or disconnect the inserted USB memory while writing is going on, or else the USB memory may possibly be damaged. Be sure to disconnect the USB memory in accordance with the procedure described under “How to write from monitor to USB memory”.
- Do not change the name of an automatically generated folder or a file, or else downloading to the monitor will be disabled. Do not modify the data in a file, or else the order of the data may be altered, disabling writing of the data.
- If there is a file already in the specified folder, the data of a new file will be overwritten on the existing file.
- High-security USB memories could not be possibly recognized.

Downloading from USB memory to monitor

④ Selecting items to be downloaded

- Select the items of data to be downloaded from the USB memory to the monitor. Tick the check box.
- Contents of individual items
 - a) MENU&SW
 - Tick this check box to download the setting statuses of all the menus (excluding USER MARKER MENU and PRESET MENU) and the switch setting status.
 - The following files that are dedicated to each model are loaded as they are model-specific files.
For HEM-1770WR:
“¥Ikegami_Monitor¥menu_sw_hem1770_001.txt”
For HEM-2570W:
“¥Ikegami_Monitor¥menu_sw_hem2570_001.txt”
 - * Since this is a model-specific file, you cannot download the data that was stored with a different model or vice versa.
 - b) USER MARKER
 - Check this box if you want to download the various settings (color, ON/OFF, XY coordinates) of “S01 (SCENE1) to S10 (SCENE10)” that were set in the USER MARKER of MENU 8.
 - The files for each scene of
“¥Ikegami_Monitor¥user_marker_001.txt” to
“¥Ikegami_Monitor¥user_marker_010.txt”
will be downloaded.
 - By changing the settings of “S01 to S10”, you can download the user markers of each scene by group or individually.

* Full HD-compatible

HLM-1750WR/2450W*/3250W supports only 1 scene, and you can only download the file “user_marker_001.txt”. In that case, make the setting items “S01 to S01”.

c) PRESET

- To download the items set on the PRESET MENU and all of the data of D65, D93, and FILE 1 ~ 8, tick this check box. If an individual FILE is specified, only the data of the specified FILE will be downloaded.
- The following files that are dedicated to each model are loaded as they are model-specific files.
For HEM-1770WR:
“¥Ikegami_Monitor¥preset_hem1770_001.txt”
For HEM-2570W:
“¥Ikegami_Monitor¥preset_hem2570_001.txt”
- * If the data is locked with a password, you cannot check the box. Please enter the password and unlock it before downloading.
- * Since this is a model-specific file, you cannot download the data that was stored with a different model or vice versa.
- * It is possible to download the file from the same model. However, the color temperature data stored in the FILE is different for each device; therefore the same color temperature cannot be achieved even if you download the data. For this reason, the PRESET data should be downloaded for the purpose of data backup on each monitor.

⑤ Executing the downloading

- To download the data of the items selected under Item ④ from the USB memory to the monitor, press **ENT** under “EXECUTE.” Refer to “How to download from USB memory to monitor” for the details of writing.
- If the file specified under Item ④ does not exist in the specific folder of the USB memory, the following message will appear:

The missing file name displayed here

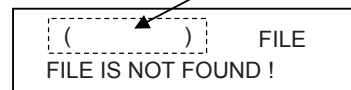

◆Precautions on downloading

- With a USB memory connected to the monitor, do not turn ON/OFF the monitor or disconnect the inserted USB memory while downloading is going on, or else the USB memory may possibly be damaged. Be sure to disconnect the USB memory in accordance with the procedure described under “How to download from USB memory to monitor”.
- Do not change the name of an automatically generated folder or a file, or else downloading to the monitor will be disabled. Do not modify the data in a file, or else the order of the data may be altered, disabling writing of the data.
- If a data in the monitor is locked with a password, “DATA LOCK” will appear on the MENU as shown on the diagram below.
Enter the password to unlock the data first and download the data.

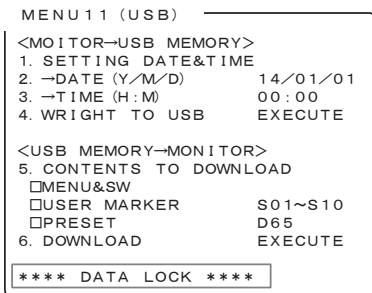

- It is possible in some cases that a high-security USB memory may not be recognized by the monitor.

◆Error messages during writing or downloading

| | |
|--------------------|---|
| ILLEGAL DATA: | Checksum error |
| FILE IS NOT FOUND: | File is not found. |
| ERROR01: | A file system error is detected |
| ERROR02: | A device other than a USB memory or a high-security USB memory is detected. |
| ERROR03~17: | Various errors on access |

How to write from monitor to USB memory

```

MENU11 (USB MEMORY)
<MONITOR - USB MEMORY>
1. SETTING OF DATE & TIME
2. -DATE Y/M/D 14/01/01
3. -TIME H:M 00:00
4. WRIGH TO MEM EXECUTE
<USB MEMORY - MONITOR>
5. CONTENTS TO DOWNLOAD
  □MENU&SW
  □USER MARKER S01~S10
  □PRESET D65
6. DOWNLOAD EXECUTE

SET- [ENT] EXIT- [ESC]
    
```

Enter the data and time of a file to be written on a USB memory.
*If no data and time is entered here, the already entered setting will be upheld.

◆Precaution
Do not draw out the inserted USB memory until the writing has been completed. If drawn out during access, the device may get damaged.

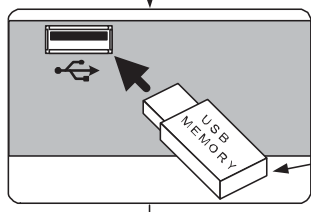

Insert a USB memory into the USB port at the monitor front.

```

MENU11 (USB MEMORY)
<MONITOR - USB MEMORY>
1. SETTING OF DATE & TIME
2. -DATE Y/M/D 14/01/01
3. -TIME H:M 00:00
4. WRIGH TO MEM EXECUTE
<USB MEMORY - MONITOR>
5. CONTENTS TO DOWNLOAD
  □MENU&SW
  □USER MARKER S01~S10
  □PRESET D65
6. DOWNLOAD EXECUTE

SET- [ENT] EXIT- [ESC]
    
```

Move the cursor to "EXECUTE" and press the [ENT] switch.

By pressing the [ESC] switch at this point, the device is disconnected and the USB memory can be drawn out.

When no USB memory is inserted:

```

MENU11 (USB MEMORY)
<MONITOR - USB MEMORY>
1. SETTING OF DATE & TIME
2. -DATE Y/M/D 14/01/01
3. -TIME H:M 00:00
4. WRIGH TO MEM EXECUTE
<USB MEMORY - MONITOR>
5. CONTENTS TO DOWNLOAD
  □MENU&SW
  □USER MARKER S01~S10
  □PRESET D65
6. DOWNLOAD EXECUTE

DEVICE: [NO CONNECT]
SET USB MEMORY
CANCEL- [ESC]
    
```

The "NO CONNECT" message appears.

When an unsupported device is inserted:

```

MENU11 (USB MEMORY)
<MONITOR - USB MEMORY>
1. SETTING OF DATE & TIME
2. -DATE Y/M/D 14/01/01
3. -TIME H:M 00:00
4. WRIGH TO MEM EXECUTE
<USB MEMORY - MONITOR>
5. CONTENTS TO DOWNLOAD
  □MENU&SW
  □USER MARKER S01~S10
  □PRESET D65
6. DOWNLOAD EXECUTE

DEVICE: [UNSUPPORTED]
SET USB MEMORY
CANCEL- [ESC]
    
```

The "UNSUPPORTED" message appears.

```

MENU11 (USB MEMORY)
<MONITOR - USB MEMORY>
1. SETTING OF DATE & TIME
2. -DATE Y/M/D 14/01/01
3. -TIME H:M 00:00
4. WRIGH TO MEM EXECUTE
<USB MEMORY - MONITOR>
5. CONTENTS TO DOWNLOAD
  □MENU&SW
  □USER MARKER S01~S10
  □PRESET D65
6. DOWNLOAD EXECUTE

PROCESSING...
    
```

In case of trouble

The device is detecting to see if the USB memory is inserted.

```

MENU11 (USB MEMORY)
<MONITOR - USB MEMORY>
1. SETTING OF DATE & TIME
2. -DATE Y/M/D 14/01/01
3. -TIME H:M 00:00
4. WRIGH TO MEM EXECUTE
<USB MEMORY - MONITOR>
5. CONTENTS TO DOWNLOAD
  □MENU&SW
  □USER MARKER S01~S10
  □PRESET D65
6. DOWNLOAD EXECUTE

DEVICE: USB MEMORY
WRITE TO USB MEMORY?
OK- [ENT] CANCEL- [ESC]
    
```

In normal state

The detection result is displayed here. When the USB memory is recognized, "USB MEMORY" appears onscreen.

When ready to write press the [ENT] switch. To interrupt it, press the [ESC] switch.

By pressing the [ESC] switch at this point, the device is disconnected and the USB memory can be drawn out.

```

MENU11 (USB MEMORY)
<MONITOR - USB MEMORY>
1. SETTING OF DATE & TIME
2. -DATE Y/M/D 14/01/01
3. -TIME H:M 00:00
4. WRIGH TO MEM EXECUTE
<USB MEMORY - MONITOR>
5. CONTENTS TO DOWNLOAD
  □MENU&SW
  □USER MARKER S01~S10
  □PRESET D65
6. DOWNLOAD EXECUTE

WRITING...
DO NOT REMOVE THE DEVICE!
    
```

During write

```

MENU11 (USB MEMORY)
<MONITOR - USB MEMORY>
1. SETTING OF DATE & TIME
2. -DATE Y/M/D 14/01/01
3. -TIME H:M 00:00
4. WRIGH TO MEM EXECUTE
<USB MEMORY - MONITOR>
5. CONTENTS TO DOWNLOAD
  □MENU&SW
  □USER MARKER S01~S10
  □PRESET D65
6. DOWNLOAD EXECUTE

JOB COMPLETED!
THE DEVICE CAN BE REMOVED.
EXIT- [ESC]
    
```

Write complete

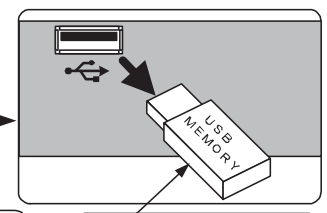

Draw out the USB memory

How to download from USB memory to monitor

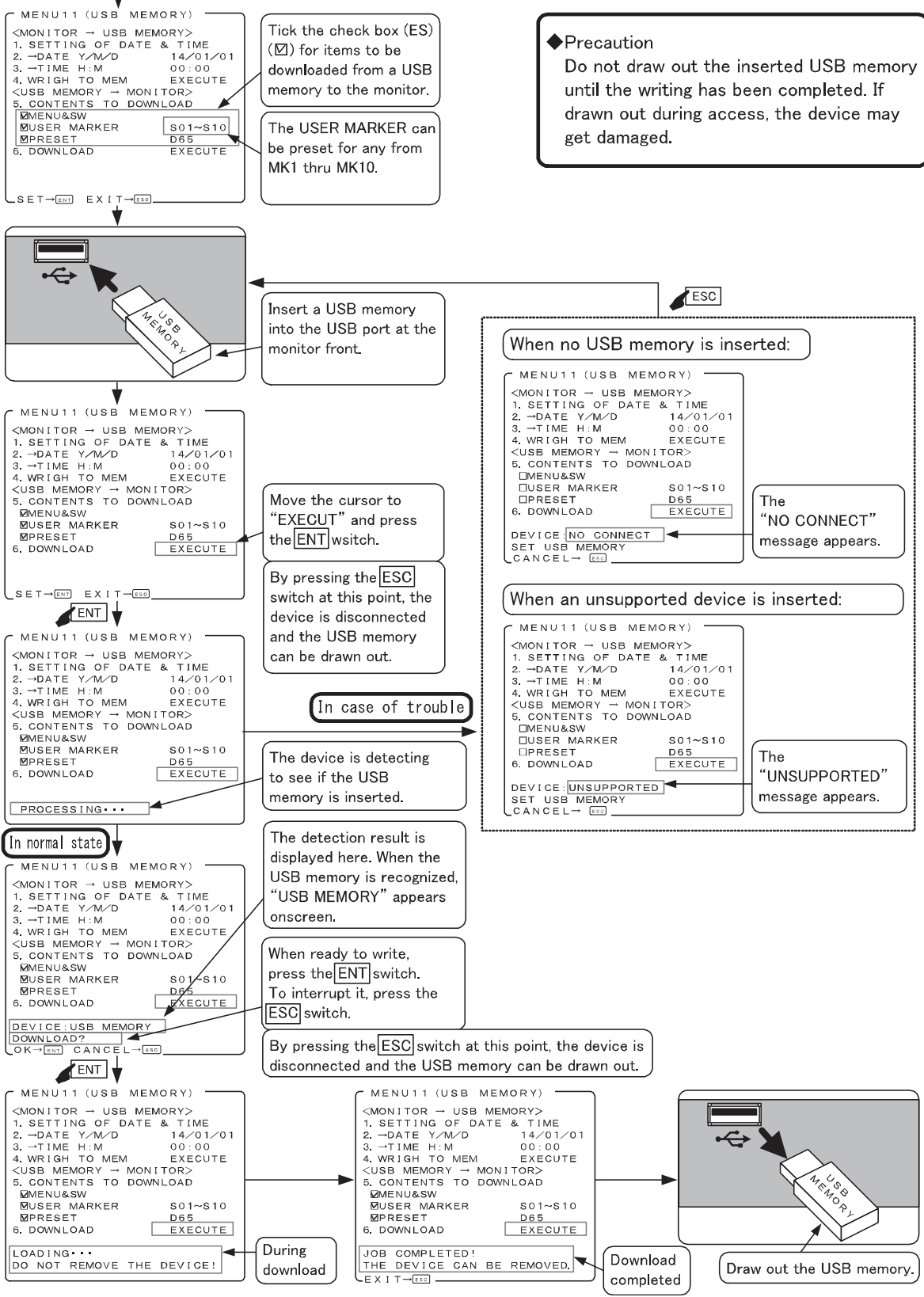

4-15. Description of MENU 12 Functions

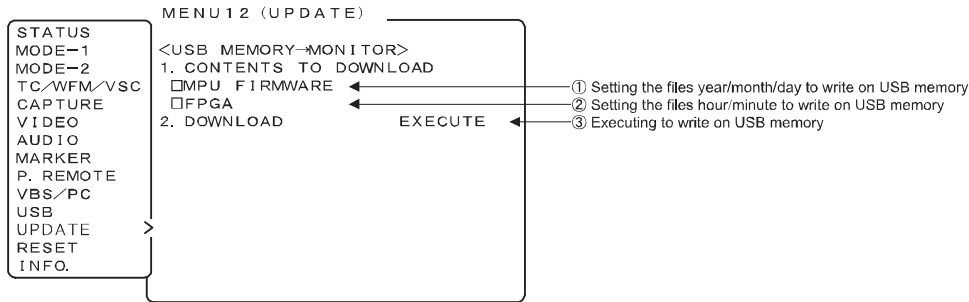

① Selecting items to be updated

- When updating the monitor by using the data stored in the USB memory, tick the check box of the items to be updated.
It is possible to download both items simultaneously.

a) MPU FIRMWARE

- When updating the MPU firmware, tick the check box here.
- It takes approximately 45 seconds to update the MPU.
- Check the "Ikegami_Monitor" folder located on the root of the USB memory for existence of the data for HEM-1770WR/2570W.

Ikegami_Monitor : Storage folder

hem1770mpu_v***.bin (for HEM-1770)
hem2570mpu_v***.bin (for HEM-2570)

- 3-digit version number is given right after the letter "v" at the end of the file name in the MPU firmware dedicated to each model, HEM-1770WR/2570W.
- If, for example, the file name is "hem1770mpu_v102.bin," it indicates that the version of the firmware is "version1.02."

b) FPGA

- When updating FPGA, tick the check box here.
- Check the "Ikegami_Monitor" folder located on the root of the USB memory for existence of the data for HEM-1770WR/2570W.

Ikegami_Monitor : Storage folder

hem1770fpga_v**.*.rpd (for HEM-1770)
hem2570fpga_v**.*.rpd (for HEM-2570)

- 2-digit version number is given right after the letter "v" at the end of the file name in the FPGA data dedicated to each model, HEM-1770WR/2570W.
- If, for example, the file name is "hem1770fpga_v02.rpd," it indicates that the version of the firmware is "version02."

② Execution of download

- Execute the updating of the item or items selected by ticking under item ①.
- Please refer to "How to update MPU from USB memory" on page 52 for the method of updating MPU.
- Please refer to "How to update FPGA from USB memory" on page 53 for the method of updating FPGA.
- When updating both MPU and FPGA simultaneously, update FPGA first and, even if an error should occur then, update MPU next.

How to update MPU from USB memory

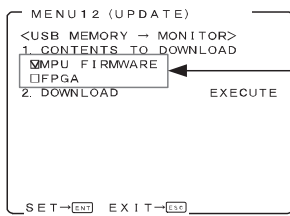

Tick the check box () for MPU item.

◆Precaution

Do not draw out the inserted USB memory until the writing has been completed. If drawn out during access, the device may get damaged.
 The USB memory use USB memory formatted in FAT12/16/32, VFAT.
 The USB cannot use USB memory with the security software.

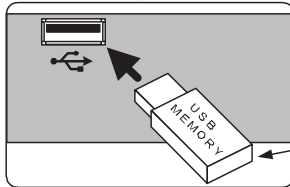

Insert a USB memory into the USB port at the monitor front.

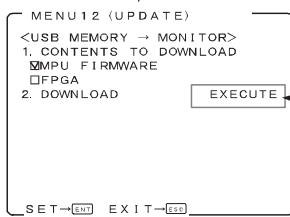

Move the cursor to "EXECUTE" and press the [ENT] switch.

By pressing the [ESC] switch at this point, the device is disconnected and the USB memory can be drawn out.

When no USB memory is inserted:

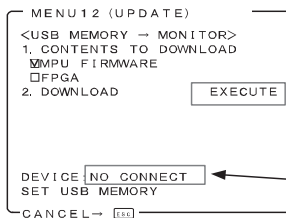

The "NO CONNECT" message appears.

When an unsupported device is inserted:

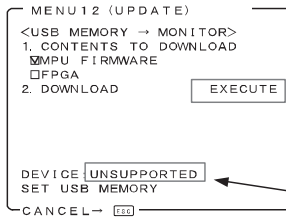

The "UNSUPPORTED" message appears.

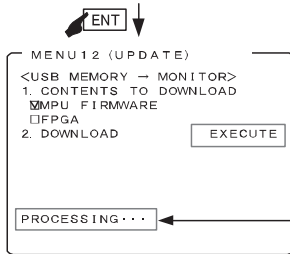

In case of trouble

The device is detecting to see if the USB memory is inserted.

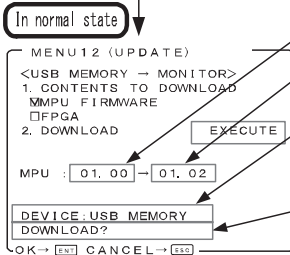

In normal state

Current version

New version

The detection result is displayed here. When the USB memory is recognized, "USB MEMORY" appears onscreen.

When ready to write, press the [ENT] switch. To interrupt it, press the [ESC] switch.

By pressing the [ESC] switch at this point, the device is disconnected and the USB memory can be drawn out.

The new version that was downloaded

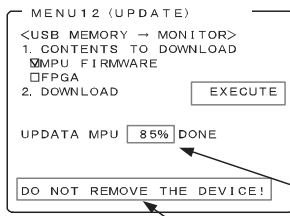

During update

Automatically resets the software after the update is completed.

Progress

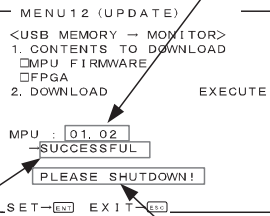

Upload success

Shutdown message

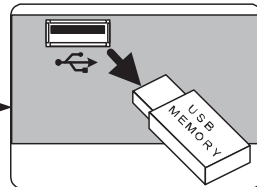

Remove the USB memory, turn the power OFF, and restart it to complete.

How to update FPGA from USB memory

◆Precaution
 Do not draw out the inserted USB memory until the writing has been completed. If drawn out during access, the device may get damaged.
 The USB memory use USB memory formatted in FAT12/16/32, VFAT.
 The USB cannot use USB memory with the security software.

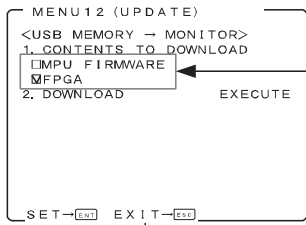

Tick the check box () for FPGA item.

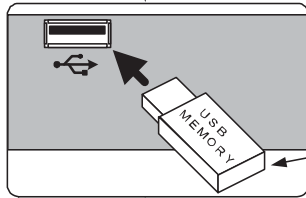

Insert a USB memory into the USB port at the monitor front.

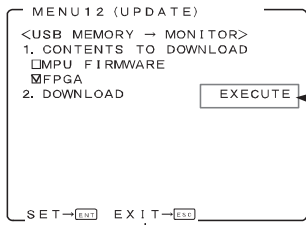

Move the cursor to "EXECUT" and press the [ENT] switch.

By pressing the [ESC] switch at this point, the device is disconnected and the USB memory can be drawn out.

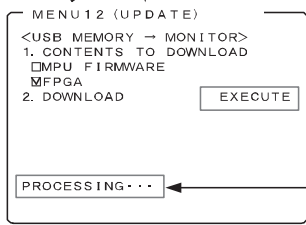
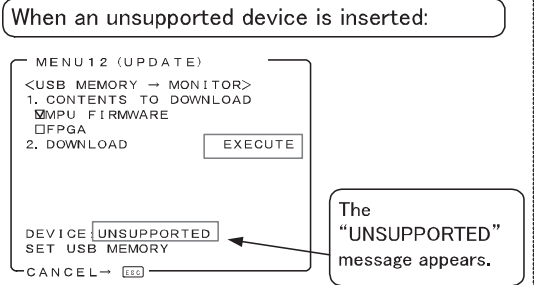
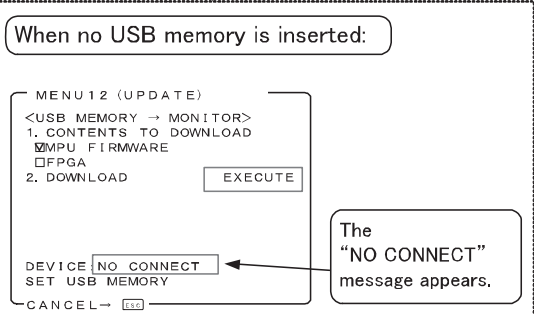

In case of trouble

The device is detecting to see if the USB memory is inserted.

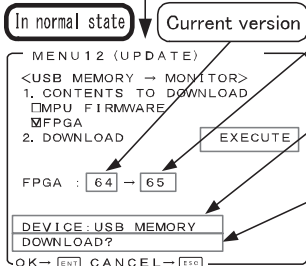
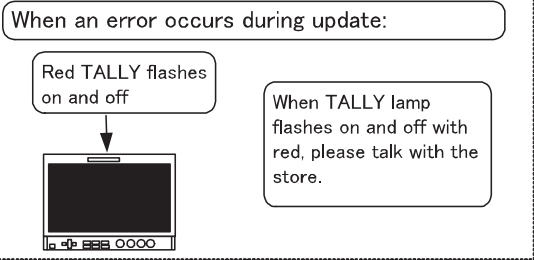

In normal state

Current version

New version

The detection result is displayed here. When the USB memory is recognized, "USB MEMORY" appears onscreen.

When ready to write, press the [ENT] switch. To interrupt it, press the [ESC] switch.

By pressing the [ESC] switch at this point, the device is disconnected and the USB memory can be drawn out.

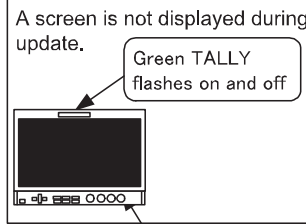

During update

In case of trouble

Automatically resets the software after the update is completed.

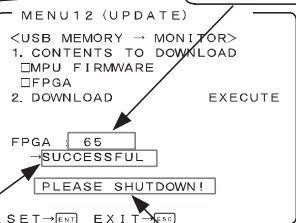

Upload success

Shutdown message

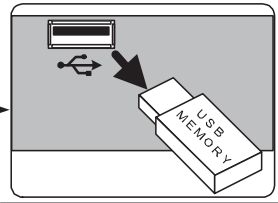

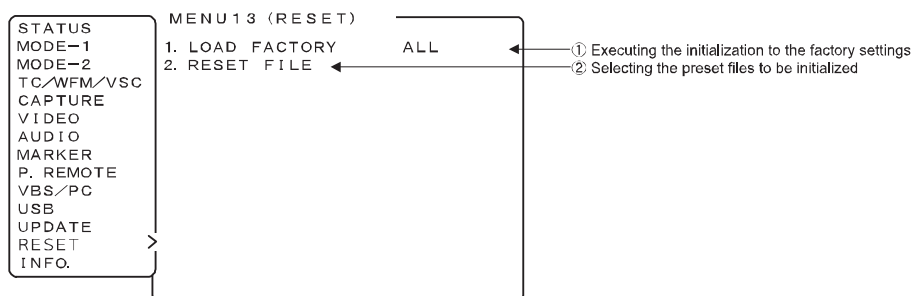

Remove the USB memory, turn the power OFF, and restart it to complete.

4-16. Description of MENU 13 Functions



① Executing the initialization of set data

- Perform this setting to restore the default settings.
- ALL : Factory settings are restored for all PRESET data, all MENUs and switches.
- PRESET : Factory settings are restored for all PRESET data.
- MENU&SW : Factory settings are restored for all MENUs and switches.
- To initialize, select an item to be initialized with the  and  switches and press the **ENT** switch. The confirmation message appears. Press the **ENT** switch again. To cancel the initialization, just press the **ESC** switch.

* The initialization of data cannot be executed if “DATA LOCK” or “ALL LOCK” is set in "5-2.

⑥ Setting of data protection password".

To initialize the data, unlock.

② Selecting the preset files to be initialized

- When “PRESET ” is selected in ① , select a file for restoring the set data to the factory-set one.
- ALL : All the preset files are initialized.
- FILEx : FILEx only is initialized.
(x:1 to 8)
- FILE1-8 : FILE1 to FILE8 only are initialized.
- D65 : REF D65 only is initialized.
- D93 : REF D93 only is initialized.
- D65/D93 : REF D65 and D93 only are initialized.

4-17. Description of MENU 14 Functions

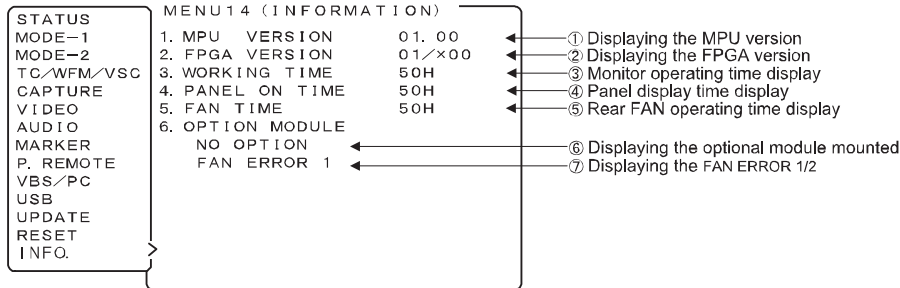

① Displaying the MPU version

- Displays the current software version.

② Displaying the FPGA 1/2 version

- Displays the current software version.

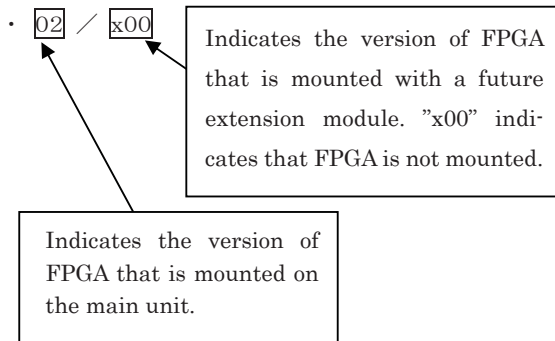

③ Displaying the working time

- Displays the accumulated time since the power was turned on.
- The time for the internal fan that is always in operation is equivalent to this accumulated time. The time for the rear fan is shown in the section ⑤.

④ Panel display time display

- The accumulated time for the panel display being ON is displayed as an indication of the time for the panel being displayed. This means that the time for when the display is turned off using "SCREEN OFF" and the time for when the "SCREEN SAVER" is activated and the display is turned off are excluded from the operation time of ③. The accumulated time does not include the time for no signal.

⑤ Rear fan operating time display

- Although the rear fan is operated according to the internal temperature, the accumulated operation time will be displayed.

⑥ Displaying the optional modules mounted

- Displays the optional module currently mounted on the monitor.
- The following message appears when no corresponding optional module is installed.
"→ NO OPTION"
- The following appear when an optional module is installed.
→CM-70 : When equipped with the CM-70.
→SP-70 : When equipped with the SP-70.
→*****: Added as necessary with the version up.

⑦ FAN ERROR 1/2 display

- If the internal or external fan on the rear side is stopped, the message "FAN ERROR!" is displayed, which allows you to check which fan is stopped. It is displayed with flashing red letters as described below.
FAN ERROR 1: External fan on the back side.
FAN ERROR 2: Internal fan

5. Preset Menu Function

5-1. List of preset menu

• To execute the preset menu, press **PRESET**.

* Turn off the menu screen.

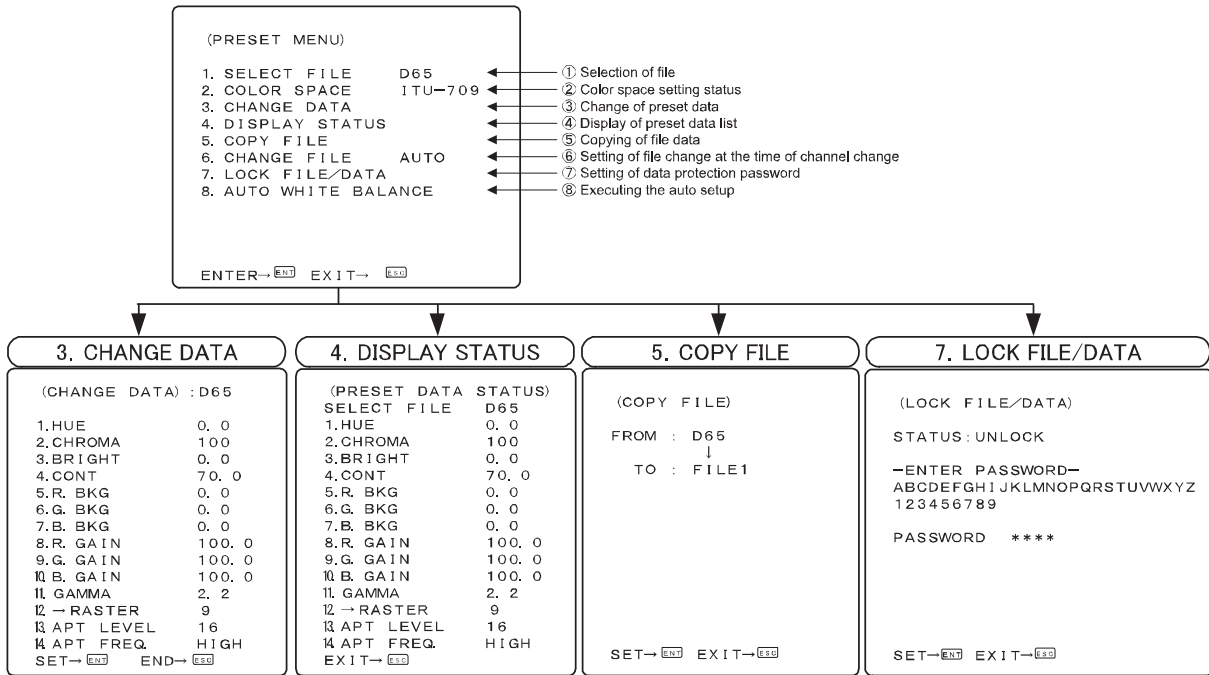

5-2. Description of preset menu

① Selection of files

• Select a file from among D65, D93 and FILE1 to FILE8.

- D65 : 6500K
- D93 : 9300K
- FILE1-8 : User files

• The following data is memorized on these 10 files.

- HUE : Hue data (only for NTSC signals)
- CHROMA : CHROMA data
- BRIGHT : BRIGHTNESS data
- CONT : CONTRAST data
- R.GAIN : R.GAIN data
- G.GAIN : G.GAIN data
- B.GAIN : B.GAIN data
- R.BKG : R.BACKGROUND data
- G.BKG : G.BACKGROUND data
- B.BKG : B.BACKGROUND data
- GAMMA : Gamma data
- RASTER : Raster brightness data
(only for CRT GAMMA)
- APT LEVEL : Aperture level
- APT FREQ. : Aperture frequency

*The D65 and D93 have been factory-set for the color temperatures of 6500K and 9300K, respectively. The FILE1 thru -8 data have been factory-set to be the same as for the D65.

② Change of preset data

| (CHANGE DATA) : D65 | | |
|---------------------|-------|-------------------------|
| 1. HUE | 0.0 | (a) File being selected |
| 2. CHROMA | 100 | (b) HUE data |
| 3. BRIGHT | 0.0 | (c) CHROMA data |
| 4. CONTRAST | 90.0 | (d) BRIGHTNESS data |
| 5. R. BKG | 0.0 | (e) CONTRAST data |
| 6. G. BKG | 0.0 | (f) R. BACKGROUND data |
| 7. B. BKG | 0.0 | (g) G. BACKGROUND data |
| 8. R. GAIN | 100.0 | (h) B. BACKGROUND data |
| 9. G. GAIN | 100.0 | (i) R. GAIN data |
| 10. B. GAIN | 100.0 | (j) G. GAIN data |
| 11. GAMMA | 2.2 | (k) B. GAIN data |
| 12. RASTER | 9 | (l) GAMMA data |
| 13. APT LEVEL | 16 | (m) RASTER data |
| 14. APT FREQ. | HIGH | (n) Aperture level |
| SET → ENT | | (o) Aperture frequency |
| EXIT → ESC | | |

• Change the data of a file selected in "(a) Selection of files" on the preceding page.

• How to change data

Select "CHANGE DATA" and press the **ENT** switch. The following "CHANGE DATA" menu appears.

• Adjustable

• HUE

Used to set the hue (only for NTSC signals).

Variable range : -18.0~+17.7

• Default setting is 0.0.

• CHROMA

Used to set the color density.

Variable range : 0.0~200.0

• Default setting is 100.

• BRIGHT (BRIGHTNESS)

Used to set the black level.

Variable range : -100.0~+60.0

• Default setting is 0.0.

• CONT (CONTRAST)

Used to set the white level.

Variable range : 0.0~100.0 (WIDE : 0.0~200.0)

• R.BKG (R.BACKGROUND)

Used to set the black balance (red component) in the dark zone.

Variable range : -100.0~+100.0

• Default setting is 0.0.

• G.BKG (G.BACKGROUND)

Used to set the black balance (green component) in the dark zone.

Variable range : -100.0~+100.0

• Default setting is 0.0.

• B.BKG (B.BACKGROUND)

Used to set the black balance (blue component) in the dark zone.

Variable range : -100.0~+100.0

• Default setting is 0.0.

• R.GAIN

Used to set the white balance (red component) in the bright zone.

Variable range : 0.0~+100.0

• Default setting is 100.0.

• G.GAIN

Used to set the white balance (green component) in the bright zone.

Range : 0.0~+100.0

• Default setting is 100.0.

• B.GAIN

Used to set the white balance (blue component) in the bright zone.

Range : 0.0~+100.0

• Default setting is 100.0.

• GAMMA

Sets the gamma setting.

CRT gamma is resembled to the gamma of Ikegami CRT master monitor HTM-1990.

Range : 2.2, 2.4, CRT

• Default setting is 2.2.

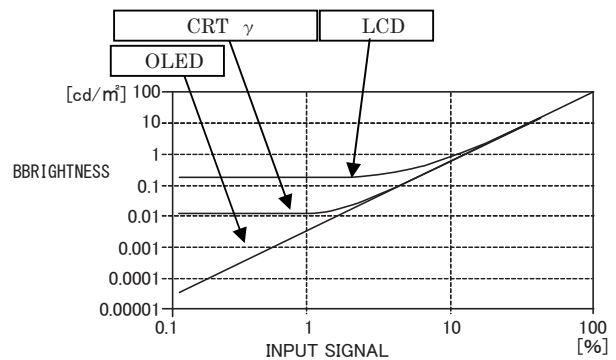

• RASTER

This is enabled only for the CRT GAMMA, and it sets the raster brightness.

Since the raster brightness of CRT monitor varies depending on the CRT, you can adjust it to your CRT monitor.

Variable range: 1 (dark) to 16 (bright)

• Default setting is 9.

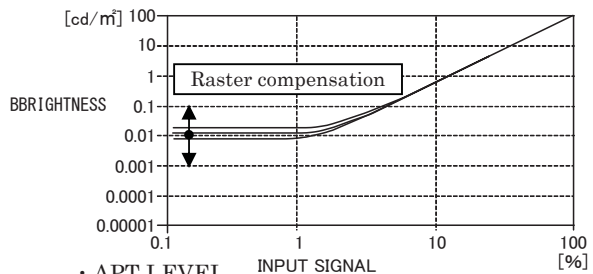

• APT LEVEL

Used to set the aperture level.

Variable range : 0~63

• Default setting is 16.

• APT FREQ.

Used to set the aperture frequency.

LOW Boosting from approx. 10MHz

MID1 Boosting from approx. 15MHz

MID2 Boosting from approx. 20MHz

HIGH Boosting from approx. 25MHz

• Default setting is HIGH.

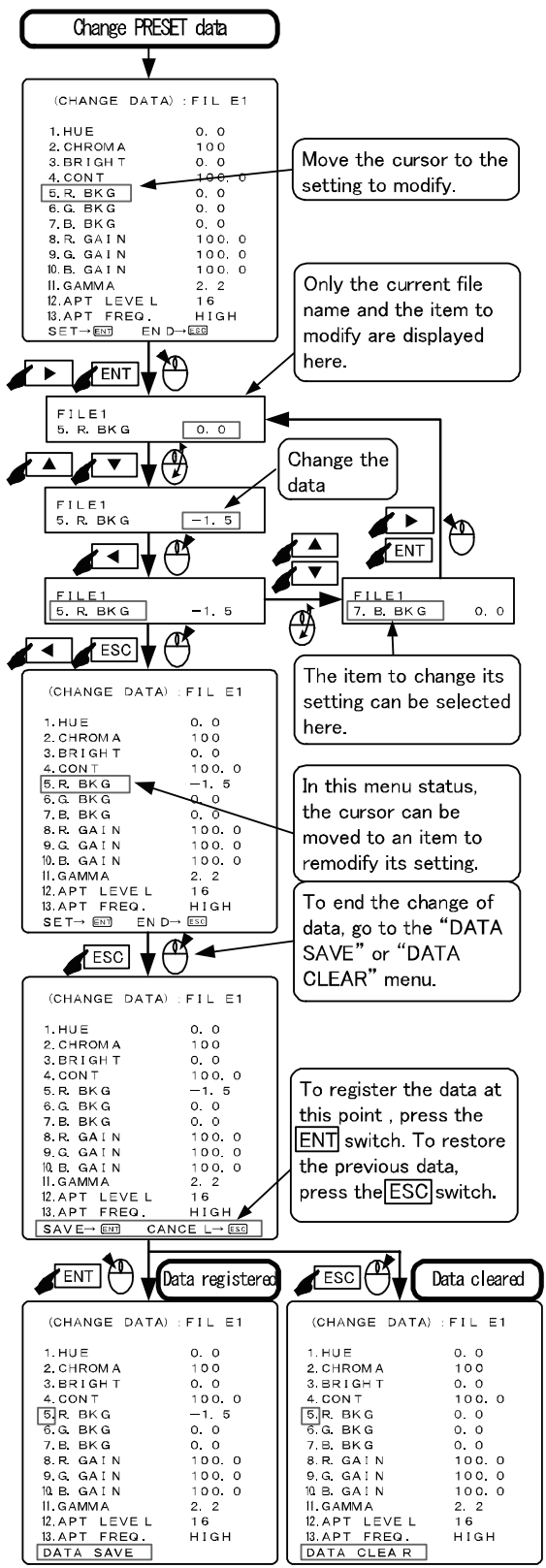

■ White balance adjustment assist function

a) Direct adjustment with the front switch
 When the PRESET data is changed, the six types of adjustment items for each white balance of "R/G/B BKG" and "R/G/B GAIN" are directly assigned to the switches on the front panel, and the illustration is displayed on the top of screen to show the switch function.

Illustration is displayed on the screen so that you can see which switch functions are assigned at glance.

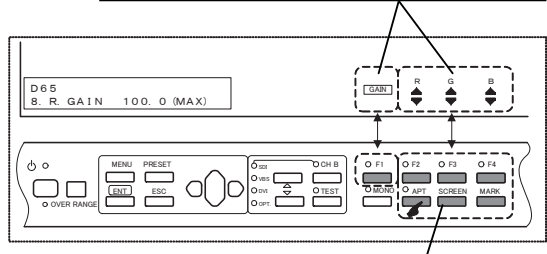

F1 switch is assigned to switch between GAIN and BACK-GROUND.

These six switches are assigned to R/G/B and their UP/DOWN volume.

b) Color temperature adjustment function with button screen using a mouse.
 The mouse menu in the section 6 includes a function that displays a button to adjust the white balance on the screen as shown in the figure below, which allows you to adjust the color temperature with ease.

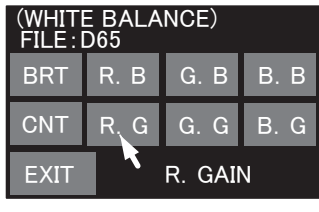

By moving the pointer over the item you want to adjust and clicking it, you can adjust the color temperature from the remote area while comparing to other models.

See the section 6-1 for details on the adjustment method.

③ Display of preset data list

| (PRESET DATA STATUS) | |
|----------------------|---------|
| SELECT FILE | D65 |
| 1. HUE | 0.0 |
| 2. CHROMA | 100.0 |
| 3. BRIGHT | 0.0 |
| 4. CONTRAST | 90.0 |
| 5. R. BKG | 0.0 |
| 6. G. BKG | 0.0 |
| 7. B. BKG | 0.0 |
| 8. R. GAIN | 100.0 |
| 9. G. GAIN | 100.0 |
| 10. B. GAIN | 100.0 |
| 11. GAMMA | 2.2 |
| 12. RASTER | 9 |
| 13. APT LEVEL | 16 |
| 14. APT FREQ. | HIGH |
| EXIT | → [ESC] |

- Display a list of the settings of file data.
- To change files, use the ◀ and ▶ switches at the SELECT FILE setting.

④ Copying of file data

| (COPY FILE) | |
|--------------------------|-------|
| FROM : | D65 |
| | ↓ |
| TO : | FILE1 |
| SET → [ENT] EXIT → [ESC] | |

- (a) Selection of copy source file (D65, D93, FILEx [x: 1 to 8]) using the ▲/▼ switch and press the [ENT] switch.
- (b) Selection of copy destination file (FILE1 - FILE8) using the ▲/▼ switch.
* When FILE1 - FILE8 are selected, data is copied to FILE1 through FILE8.
- (c) When the [ENT] switch is pressed, the copy confirmation message appears. To copy, press the [ENT] switch again. If not, press the [ESC] switch.

⑤ Setting of file change operation at the time of channel change

- Set the association of channel change with file change.
 - AUTO: Files are memorized for each channel: When a channel is changed to another, an automatically stored files picked up.
 - MANUAL: Just one file preset for all channels is fixed.
- Default setting is AUTO.

⑥ Setting of data protection password

- A password is set to prevent modifications of the preset data and the initialization.

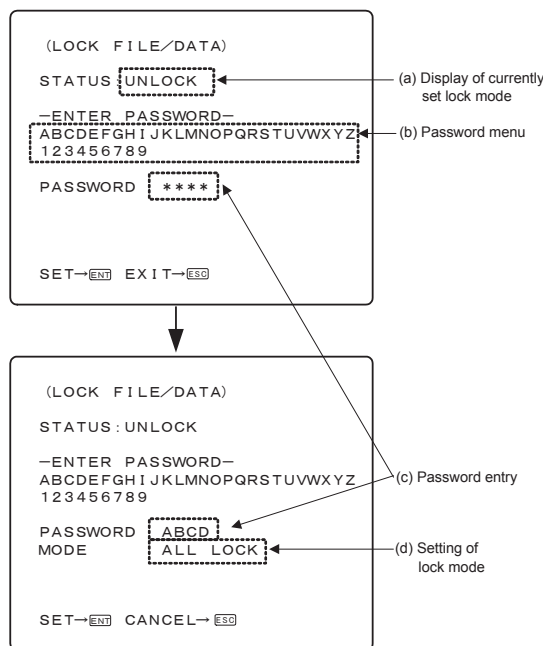

- (a) Display of currently set lock mode
 - The currently set lock mode is displayed.
 - UNLOCK : The lock is released and all data can be changed.
 - DATA LOCK : Preset data change is locked, although file change impossible.
 - ALL LOCK : Preset data change and file change are impossible.
- (b) Password menu
 - Select characters from this list using the ▲, ▼, ◀ and ▶ switches and press the [ENT] switch to set the password.
- (c) Password entry
 - When setting the lock mode to ALL LOCK or DATA LOCK or when releasing the lock mode (UNLOCK), select characters from the menu in ② and enter a four-digit password here.
 - * If you forget the registered password, contact Ikegami's service office. They have a password for releasing the lock.
- (d) Setting of LOCK mode
 - When the [ENT] switch is pressed after the password has been entered, the LOCK mode blinks. Execute the setting by pressing the [ENT] key. To return to the previous state, press the [ESC] switch.

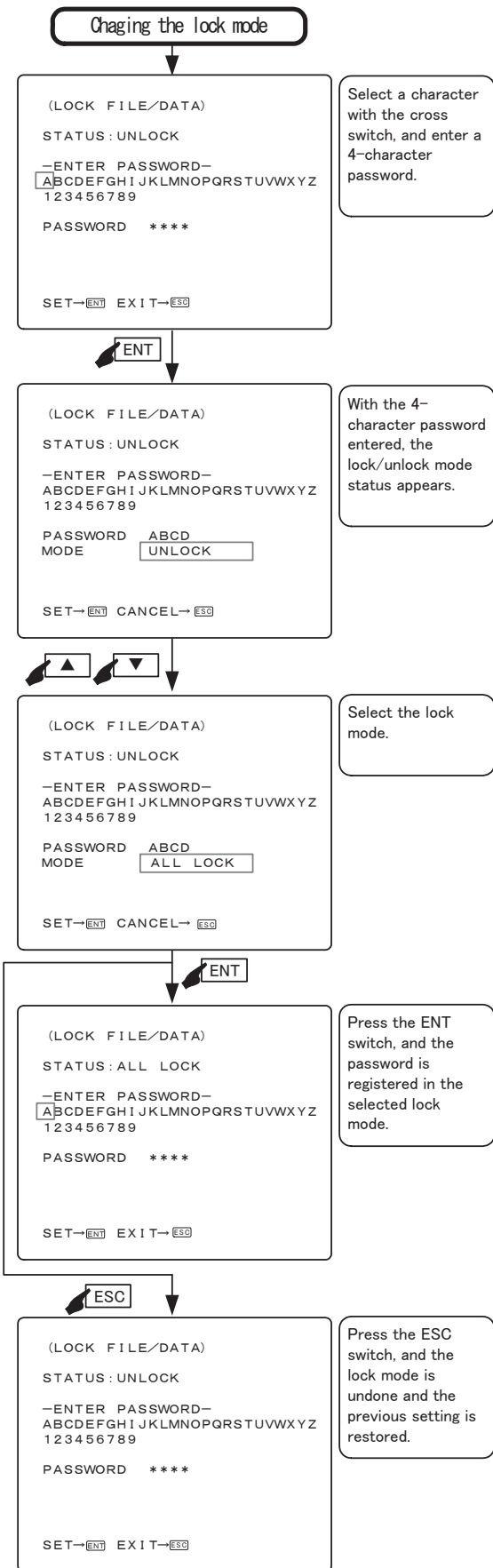

6. Mouse menu function

6-1. Basic procedure of the mouse menu

Basic behavior of the mouse
The USB mouse requires the following 5 functions. Remote control is enabled using a 2.4GHz wireless mouse.

The mouse basically behaves in the same way as the switches on the front panel bottom.

- ① Double click
 - The mouse menu is display
- ② Left click
 - A selected item in the menu is moved to the right.
 - The data is registered.
- ③ Right click
 - A selected item in the menu is moved to the left.
 - The data is cleared
- ④ Center click
 - The mouse menu is enlarged
- ⑤ Scroll wheel
 - A selected item is moved up and down.
 - The data is modified.

<Normal screen>

① The [MAIN] menu is displayed.

```

[STATUS] MENU1 (STATUS) : 10801/60
MODE-1 HEM-1770WR
MODE-2 >PRESET FILE D65
TC/WFM/VSC >COLOR SPACE 1TU-709
CAPTURE >GAMMA 2.2
VIDEO >FUNCTION1 MODE WFM ON
AUDIO >FUNCTION2 MODE SCR OFF
MARKER >FUNCTION3 MODE MIX TEST
P. REMOTE >POWER ON STATUS OFF
VBS/PC
USB
UPDATE
RESET
INFO.
  
```

② The [PRESET] menu is displayed.

```

(PRESET MENU)
1. SELECT FILE D65
2. COLOR SPACE 1TU-709
3. CHANGE DATA
4. DISPLAY STATUS
5. COPY FILE
6. CHANGE FILE AUTO
7. LOCK FILE/DATA
8. AUTO WHITE BALANCE

ENTER → [ENT] EXIT → [ESC]
  
```

③ The [MOUSE MENU] INPUT menu is displayed.

In the standard mode

```

MOUSE MENU
<INPUT>
 *SDI-A
 SDI-B
 VBS-A
 VBS-B
 DV1
 OPT-A
 OPT-B
 TEST
  
```

In the enlarged mode

```

MOUSE MENU
<INPUT>
 *SDI-A
  
```

- In this menu, the input signals can be selected.
- In the enlarged mode, only a selected line is displayed.
- The *mark shows the selected input channel.
- By scrolling, the items can be changed.

④ The [MOUSE MENU] FUNCTION menu is displayed.

In the standard mode

```

MOUSE MENU
<FUNCTION>
 1 : WFM ON
 2 : SCR OFF
 3 : MIX TEST
 4 : LIGHT ON
 MONO
 MARK
 APT
 SCREEN
  
```

In the enlarged mode

```

MOUSE MENU
<FUNCTION>
 1 : WFM ON
  
```

- In this menu, the same functions as with the front switches can be selected.
- Numbers 1 and 2 mean F1 and F2, respectively.
- In the enlarged mode, only a selected line is displayed.
- By scrolling, the items can be changed.

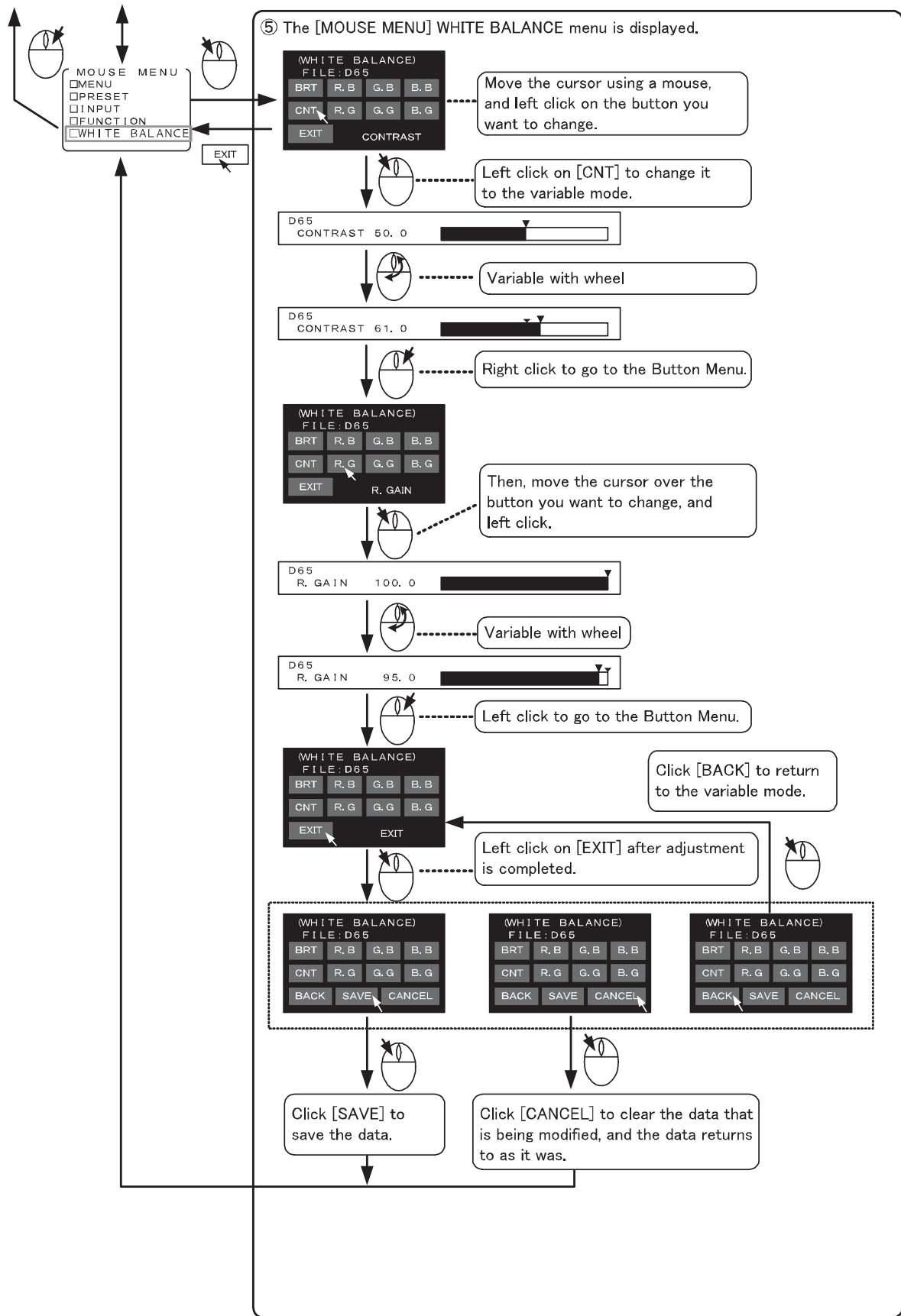

6-2. Basic procedures on the MENU and PRESET MENU screens

① Basic mouse behavior on the MENU screen

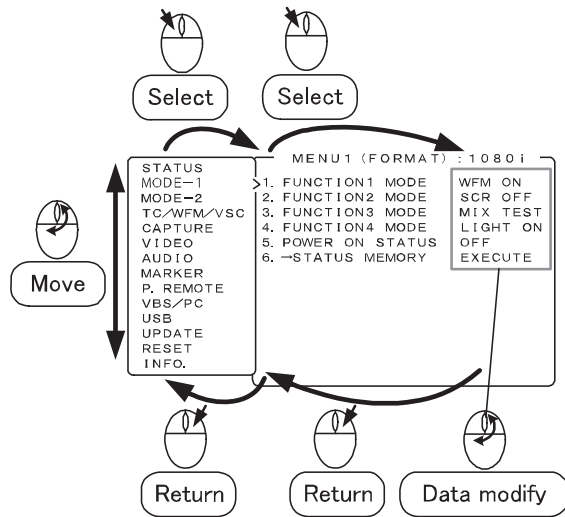

- Left-click the mouse to go to the right of the MENU screen and select an item. Right-click it to return to the left-hand items.
- The scroll wheel is used to move vertically and to change the settings.
- When there are two or more settings to select on the right-hand data like the USB memory's date setting, left-click the mouse to go to the settings to modify.

② Basic mouse behavior on the PRESET MENU screen

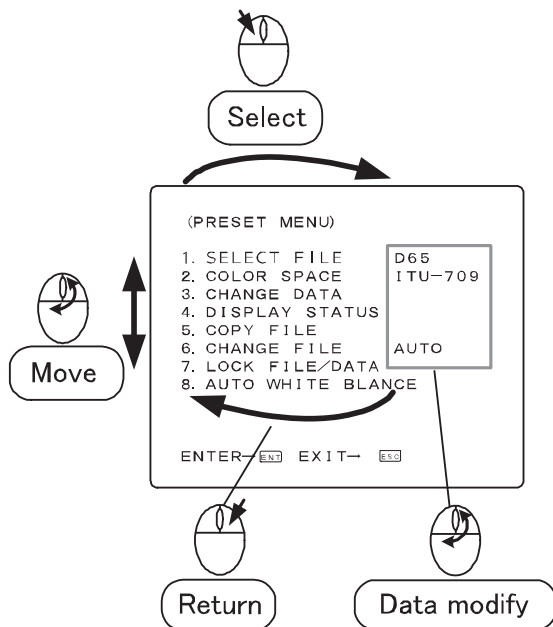

- The behavior is the same as Item ①.

③ Basic mouse behavior on the CHANGE PRE-SET screen

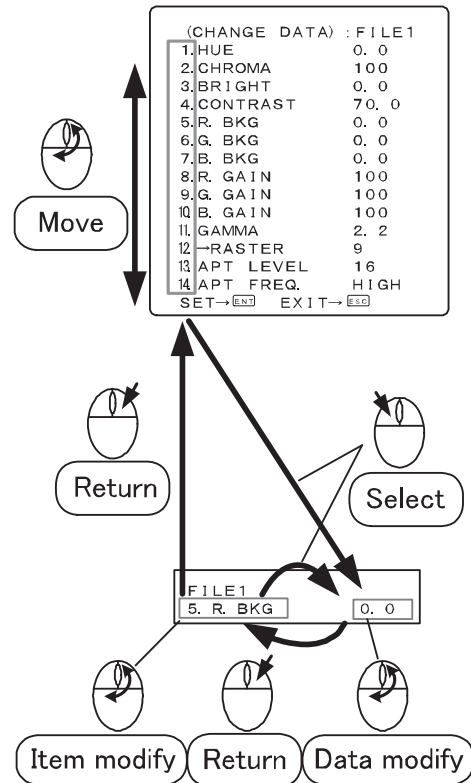

- The behavior is the same as Item ①.

④ Basic mouse behavior on the USER MARKER screen

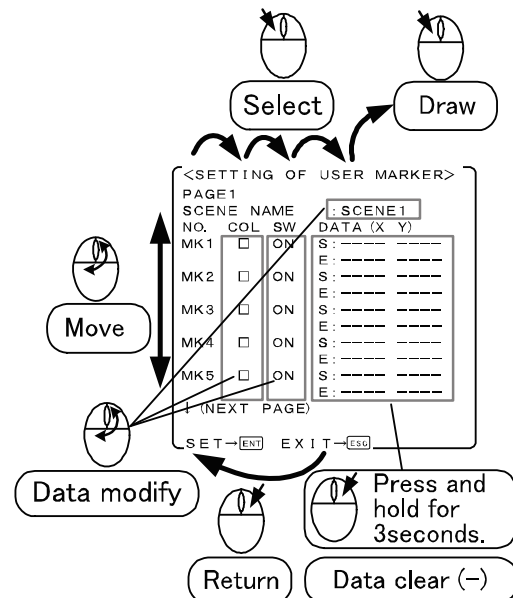

- The behavior is the same as Item ①.

7. Specifications

7-1. General specifications

(1) Supply voltage

AC input

- 100V~120V±10% 50/60Hz
- 200V~240V±10% 50/60Hz

DC input (only for HEM-1770WR)

- DC+12V (+10.5V~+18V)

(2) Power consumption

[HEM-1770WR]

a) AC input: 81W max

- AC100V~120V : 0.8A max
- AC200V~240V : 0.4A max

b) DC input: 76W max (DC-12V)

6.3A max

[HEM-2570W]

AC input: 135W max

- AC100V~120V : 1.4A max
- AC200V~240V : 0.7A max

(3) Ambient operating temperature/humidity, ambient storage temperature/humidity

Operation: 0°C to +35°C, 20% to 85%
(no condensing)

Storage: -20°C to +60°C, 5% to 85%
(no condensing)

Maximum wet-bulb temperature: 29°C

(4) Outside dimensions (excluding protrusions)

[HEM-1770WR]

428mm(W)×301mm(H)×98mm(D), 7U

[HEM-2570W]

585mm(W)×398mm(H)×102.8mm(D), 9U

(5) Weight

[HEM-1770WR]

Approx.7.5kg (excluding the stand and option)

[HEM-2570W]

Approx.11.4kg (excluding the stand and option)

Approx.13.8kg (including the standard stand)

(6) Standard accessories

Tilt stand (HEM-2570W only),

Handle (HEM-2570W only),

Operation manual, Parallel remote connector,

AC Power cable

x1 each

7-2. Rated performance

(1) SDI signal (supported as standard)

a) Input/output terminal

Input: BNC 2 lines

Output: BNC 1 line (Active loop through
for only one line selected)

b) Input signal format (Auto detection)

• 3G-SDI : SMPTE425M-A/B

1080p/60,59.94 1080p/50

• HD-SDI : SMPTE292M

1035i/60,59.94 1080p/25

1080i/60,59.94 1080p/24,23.98

1080i/50 720p/60,59.94

1080psF/30,29.97 720p/50

1080psF/25 720p/30,29.97

1080psF/24,23.98 720p/25

1080p/30,29.97 720p/24,23.98

• SD-SDI (4:2:2) : SMPTE 259M

480i/59.94 575i/50

c) Input level

Rating: 800mVp-p±10%

d) Transmission speed

3G-SDI: 2.970Gb/s

HD-SDI: 1.485Gb/s

SD-SDI: 270Mb/s

e) Quantization bit rate

10 bits

f) Input/output impedance

75Ω

g) Transmission distance

Over 100m (5CFB, 2.97Gb/s)

(2) Analog composite (NTSC/PAL) signal (supported as standard)

a) Input terminal

BNC 2 lines (Loop through)

b) Input signal format

NTSC composite signal (SMPTE 170M)

PAL composite signal (EBU)

c) Input level

VS: 1.0Vp-p, Positive polarity

V: 0.714Vp-p (NTSC)/0.7Vp-p (PAL),
Positive polarity

d) Input impedance

High impedance bridge connection or 75Ω

termination

(75Ω termination plug is optional.)

(3) External sync signal (when the optional CM-70 is mounted)

a) Input terminal

BNC 1 line (Loop through)

b) Input level

0.3 to 4 Vp-p, three values in positive and
negative polarities, two values in negative
polarity

c) Input impedance

High impedance bridge connection or 75Ω

termination

(75Ω termination plug is optional.)

**(4) Analog component (RGB/YPbPr) signal
(when the optional CM-70 is mounted)**

- a) Input terminal
BNC 1line (single end)
- b) Input signal format
- HDTV
- | | |
|------------------|-------------|
| 1035i/60,59.94 | SMPTE 240M |
| 1080i/60,59.94 | SMPTE 274M |
| 1080i/50 | SMPTE 274M |
| 1080psF/30,29.97 | SMPTE RP211 |
| 1080psF/25 | SMPTE RP211 |
| 1080psF/24,23.98 | SMPTE RP211 |
| 1080p/60, 59.94 | |
| 1080p/50 | |
| 1080p/30,29.97 | SMPTE 274M |
| 1080p/25 | SMPTE 274M |
| 1080p/24,23.98 | SMPTE 274M |
| 720p/60,59.94 | SMPTE 296M |
| 720p/50 | SMPTE 296M |
| 720p/30,29.97 | SMPTE 296M |
| 720p/25 | SMPTE 296M |
- SDTV
- | | |
|------------|------------|
| 480i/59.94 | SMPTE 253M |
| 575i/50 | EBU N10 |
| 480p/59.94 | SMPTE 293M |
- c) Input level
Y/GBR: 0.7V_{p-p} (except SYNC),
Positive polarity
Pb, Pr: ±0.35V_{p-p}, Positive polarity
SYNC: ±0.3V_{p-p} (SYNC on Y/G)
- d) Input impedance
75Ω termination

(5) DVI-D and Analog PC signal

(Analog when the optional CM-70 is mounted)

- a) Input terminal
ANALOG: HD D-SUB 15-pin (female) 1 line
(when the optional CM-70 is mounted)
DIGITAL: DVI-D single link 24-pin (female)
1 line (supported as standard)
- b) Input signal format
- DVI-D (VIDEO)
- | | |
|------------------|---------------|
| 1080i/60,59.94 | 720p/60,59.94 |
| 1080i/50 | 720p/50 |
| 1080psF/30,29.97 | 720p/30,29.97 |
| 1080psF/25 | 720p/25 |
| 1080psF/24,23.98 | 720p/24,23.98 |
| 1080p/60,59.94 | |
| 1080p/50 | |
| 1080p/30,29.97 | |
| 1080p/25 | |
| 1080p/24,23.98 | |
| 480i/59.94 | |
| 575i/50 | 480p/59.94 |
- DVI-D(PC), Analog PC signal format
→Refer to "Data 1 PC Input Signal Com-

patible Format".

- c) Input level
Analog RGB: 700mV_{p-p}, Positive polarity
DVI-D: TMDS
- d) Input impedance
Analog PC : 75 Ω
DVI-D : 50 Ω

(6) Embedded audio common specifications

- a) Input signal format
- SMPTE 425M-A/B
1080p/60, 59.94 1080p/50
 - SMPTE 299M
1035i/60, 59.94 1080p/25
1080i/60, 59.94 1080p/24, 23.98
1080i/50 720p/60, 59.94
1080psF/30,29.97 720p/50
1080psF/25 720p/30,29.97
1080psF/24,23.98 720p/25
1080p/30,29.97 720p/24,23.98
 - SMPTE 272M
480i/59.94 (4:2:2) 575i/50 (4:2:2)
- b) Format detection
Auto detection
- c) Sampling frequency
48kHz (Synchronized with video clock)
- d) Embedded audio output
By selecting one of the pair channels of
ch1/2, ch3/4, ch5/6, and ch7/8 and DOWN-
MIX, the audio can be output from the
analog audio output terminal, headphone
output terminal, and built-in stereo
speaker.

(7) Embedded audio level meter

- a) Display method
Superimposition on screen
- b) Display channel
8 ch
- c) Display position
4 types
- d) Display mode
8 modes
- e) Display segment
26 segments (including -∞)
- f) Segment point
-∞, -60, -54, -48, -44, -40, -38, -36, -34, -32,
-30, -28, -26, -24, -22, -20, -18, -16, -14, -12,
-10, -8, -6, -4, -2, 0dB
- g) Display color
Reference level (-18dBFS or -20dBFS) is
select in MENU.
- -20dBFS
- | | |
|-------------|--------|
| -∞ ~ -22dB: | Green |
| -20 ~ -2dB: | Yellow |
| 0dB: | Red |

- -18dBFS
- ∞ ~ -20dB: Green
- 18 ~ -2dB: Yellow
- 0dB: Red

- h) Peak hold
About 1 sec
* It can be set to "OFF" with the MENU setting.
- i) Release time
About 0.4 sec

(8) Analog audio input

- a) Input terminal
RCA 2 line
- b) Input level
0dBV max
*0dBV = 1Vrms

(9) Analog audio output

- a) Output terminal
RCA 2 line
- b) Output level
0dBV max
(digital audio data: at the 0dBFS)
*0dBV=1Vrms
- c) Output impedance
10Ω or more
- d) Input signal source
Analog audio input or embedded audio input can be outputted. A signal to be outputted is set on MENU(DOWNMIX, CH1/2, CH3/4, CH5/6, CH7/8).

(10) Headphones output

- a) Output terminal
Φ3.5 Stereo mini jack type
- b) Output
85 mW/ch (RL: 32 Ω, distortion factor: 1%)
- c) Input signal source
Analog audio signal or embedded audio signal can be outputted.
To select one of these signals, make the setting on MENU(DOWNMIX, CH1/2, CH3/4, CH5/6, CH7/8).

(11) Speaker output

- a) 2-channel output
1W+1W or more (distortion factor: 1.5%)
- b) Input signal source
Analog audio input or embedded audio input can be outputted. A signal to be outputted is set on MENU (DOWNMIX, CH1/2, CH3/4, CH5/6, CH7/8).
* With the headphones being connected, no sound is heard from the speakers.

(12) Color space

4 types: ITU-R BT.709, EBU, SMPTE-C, NATIVE

(13) Color temperature setting

10 types: D65, D93, and USER setting: 8 types (FILE 1 to 8)

(14) Gamma setting

3 types: 2.2, 2.4, CRT (with raster correction)
* CRT: Similar to gamma of Ikegami HTM-1990R
The raster correction can be set arbitrary.

7-3. Specifications for OLED module

(1) Number of pixels

1920 (H) x 1080 (V) dots

(2) Screen size (display area)

[HEM-1770WR]
365.76mm(H) × 205.74mm(V)
(Diagonal 42 cm, 16.5 V type)
[HEM-2570W]
543.36mm(H) × 305.64mm(V)
(Diagonal 62 cm, 24.5 V type)

(3) Peak brightness (brightness performance for the single panel)

More than 250 cd/m²

(4) Contrast ratio

5000:1 (typ.)
* EIAJ ED-2810 dark place, partial lighting contrast

(5) Number of display colors

1000.7 million colors (10bits)

(6) Viewing angle

Vertical/horizontal: 178° (contrast ratio: 10:1 or more)

7-4. Functions

(1) Front operation

- Switch
POWER ON/OFF, CH A/B, INPUT(SDI/VBS/DVI/OPT), MONO, SCREEN, APT, MARKER, F1, F2, F3, F4, MENU, PRESET, ENT, ESC, TEST
- Volume
CHROMA, BRIGHTNESS, CONTRAST, AUDIO

(2) Marker function

- a) Center marker
(Set to ON/OFF using MENU settings)
- b) Safety marker
Any of the following markers is displayed according to the image aspect ratio (4:3/16:9). The numbers in parentheses show the aspect at the time of marker display.

<Types>

- “Safety area marker” + 100% (4:3/16:9)
The “safety area markers” are effective over the entire screen and can be preset 1% by 1% in the range of 80-99%.
- 5 divided crosshatch (4:3/16:9)
- 10 divided crosshatch (4:3/16:9)
- Cross (4:3/16:9)
- 16:9 aspect marker (4:3)
- 15:9 aspect marker (4:3/16:9)
- 14:9 aspect marker (4:3/16:9)
- 13:9 aspect marker (4:3/16:9)
- 4:3 aspect marker (16:9)
- 1.85:1 aspect marker (16:9)
- 2.35:1 aspect marker (16:9)
- “Each aspect marker” + “Safety marker in aspect” (4:3/16:9)

The “safety marker in aspect” refers to the safety marker with respect to the aspect marker display zone, and can be preset 1% by 1% in the range of 80-99%.

Corresponding to each aspect marker.

<Marker level>

- Set in five steps of 20%, 40%, 60%, 80% and 100%

(3) Shadow function

Creates a shadow outside the aspect areas with 4:3 (16:9 mode), 13:9, 14:9, 15:9, 16:9 (4.3 mode), 1.85:1 (16:9 mode) and 2.35:1 (16:9 mode).

<Types>

- “Various aspect markers” + “Shadow”
- “Various aspect markers” + “Safety marker in aspect” + “Shadow”
- Shadow only

<Shadow contrast level>

- Set in four steps of 0%, 20%, 40% and 60%.

(4) User marker function

Function for the user to draw their desired lines and boxes in the unit of pixels.

- a) No. of types: 100 types: 10 scenes x 10 types (1 scene: 10 types)
- b) No. of colors: 6
- c) Drawable sizes: 1920 x 1080 pixels
- d) Drawing method: Switch or USB mouse

* Patent pending

(5) USB memory function

- a) Content of the memory
 - MENU setting
 - User marker
 - PRESET data
 - Full capture image
- b) Stored image
 - No. of stored images: Max. 100 images
 - Resolution: 1920×1080
 - File format: Binary file for exclusive use of the monitor
 - Data capacity: 7 Mbyte

7-5. Remote Control

(1) Parallel remote control

Input connector: HD D-SUB 15-pin

- CH A/B switching
- SDI ON/OFF
- COMPONENT ON/OFF
- DVI-D ON/OFF
- ANALOG PC ON/OFF (★)
- COLOR/MONO switching
- YPbPr/RGB switching
- 4:3/16:9 switching
- SYNC INT/EXT switching
- MARKER ON/OFF
- SHADOW ON/OFF
- R TALLY ON/OFF
- G TALLY ON/OFF
- CROMA UP ON/OFF
- SHADOW0 ON/OFF (★)
- SHADOW20 ON/OFF (★)
- SHADOW40 ON/OFF (★)
- SHADOW60 ON/OFF (★)
- USER MARKER SCENE* ON/OFF (★)

* : 1~10

* For the pin function, refer to "Data 2 Parallel Remote Pin Function".

* In addition to default setting, user setting is possible.

The “★” marked settings are used in the USER mode.

(2) RS485 remote control

(The controller SRC-400 is optional.)

- a) Connector: RJ-45 (loop-through)
- b) Maximum number of connections: 32 units
Extension by increasing the number of lines is possible.

(3) Wireless remote control

[Controller RCT-30A is optional]

* See "Reference 4: Control with remote controller" for the control items."

8. Applicable Standards

8-1. Safety standards

- UL1419 (HEM-1770WR)
- UL60950-1 (HEM-2570W)
- EN60950-1 (HEM-1770WR/2570W)

8-2. Electromagnetic interference

- VCCI(Class-A)
- FCC(Class-A)
- EN55103-1 E4
- EN55103-2 E4
- EN55022(Class-A)

8-3. Environmental regulations

- Compliant with RoHS Directive

9. Mounting Bracket

Equipped with "100mm x 100mm" mounting holes compliant with the VESA mount interface standards.

Other mounting holes also available.

(Refer to the external view.)

10. Options

Any one of the following optional modules can be mounted. Each module is of plug-in type for easy replacement.

(1) CM-70 (Under development)

"RGB/YPbPr, EXT SYNC module"

RGB/YPbPr: BNC 1 line, single end

EXT SYNC: BNC 1 line, loop through

PC analog RGB: HD D-sub, 15-pin (female),

1 line, single end

(2) SP-70 (Under development)

"SFP I/F module"

This module is an interface module that can mount a generic SFP module, and is required to mount the SFP module.

There are two SFP modules that can be mounted.

SFP modules that can be currently mounted.

- HDMI (with HDCP) module
- EB30HD2R-LN (3G-SDI 2 input)
- EB30HDRT-LN (3G-SDI 1 input/1 output)

(3) ASP-100 Rev02

"Auto setup probe"

It can automatically adjust the color temperature for each gradation with PC-less operation.

Chromaticity and brightness can be also measure.

Weight: Approximately 100 g

(4) SRC-400

"Serial remote controller"

A serial remote controller that allows you to remote control the monitor with RS485 interface by loop-through connection via LAN cable. One controller can control all functions of monitors. By connecting the monitors with the loop-through connection via LAN cable, one line can control 32 monitors, and three lines can control up to 96 monitors individually or all at once.

Since the controller can be also connected with PC and Ethernet, it is possible to individually control each monitor from the PC screen through the network control.

(5) RCT-30A

"Infrared remote controller"

Just this unit can control most of the monitor functions. Up to 99 monitors can be controlled individually.

(6) BB-1750V (for HEM-1770WR)

"Battery bracket (V mount type)"

Weight: Approximately 0.29 kg

(7) BB-1750A (for HEM-1770WR)

"Battery bracket (anton mount type)"

Weight: Approximately 0.37 kg

(8) RS-1710/1770 (for HEM-1770WR)

"19-inch rack mount bracket (fixing type)"

Height: 7U

Weight: Approximately 0.76kg

Color: Gray (RS-1710), black (RS-1770)

(9) RS-1770/1770T (for HEM-1770WR)

"19-inch rack mount bracket (angle fixing type)"

Tilt angle: Adjustable on 4 levels with angle (pitch) of 3.75°

15° Max.

Height: 7U

Weight: Approximately 1.4kg

Color: Gray (RS-1710T), black (RS-1770T)

(10) STD-1770 (for HEM-1770WR)

"Fixed stand"

Color: Black

(11) STD-1770T (for HEM-1770WR)

"Tilt-Stand"

Weight: Approximately 2.0kg

Color: Black

(12) STD-1722M (for HEM-1770WR)
"Fixing stand for monitor shelf"
The top/bottom and left/right position can be adjusted with the VESA mount type stand.
Weight: Approximately 1.4kg
Color: Gray

(13) GR-1770
"Handle"
Color: Blue
Only HEM2570 is equipped standardly.

(14) MH-1750 (for HEM-1770WR)
"Food for 17-inch model"
Weight: Approximately 1.4kg

(15) MH-2570 (for HEM-2570W)
"Food for 25-inch model"

(16) CC-E17 (for HEM-1770WR)
"Hard carrying case for 17-inch model"

(17) CC-E25 (for HEM-2570W)
"Hard carrying case for 25-inch model"

* The specifications and appearance of this product are subject to change for product improvements without notice.
* Black spots and luminescent spots may occur in 0.01% or less of the effective pixels of this product. This is not a failure.

10. External View

(1) HEM-1770WR

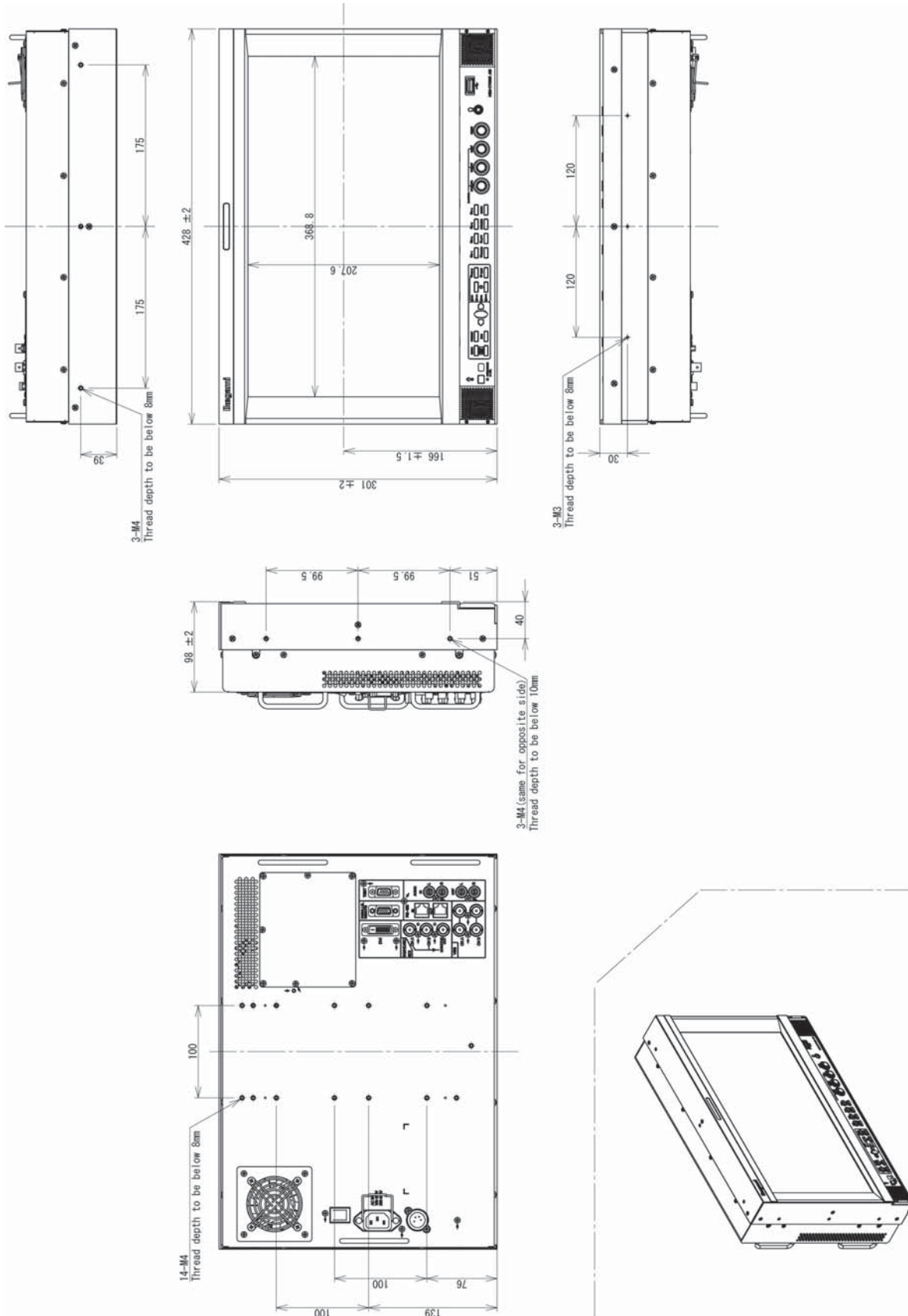

(2) HEM-1770WR+STD-1770T+GR-1770

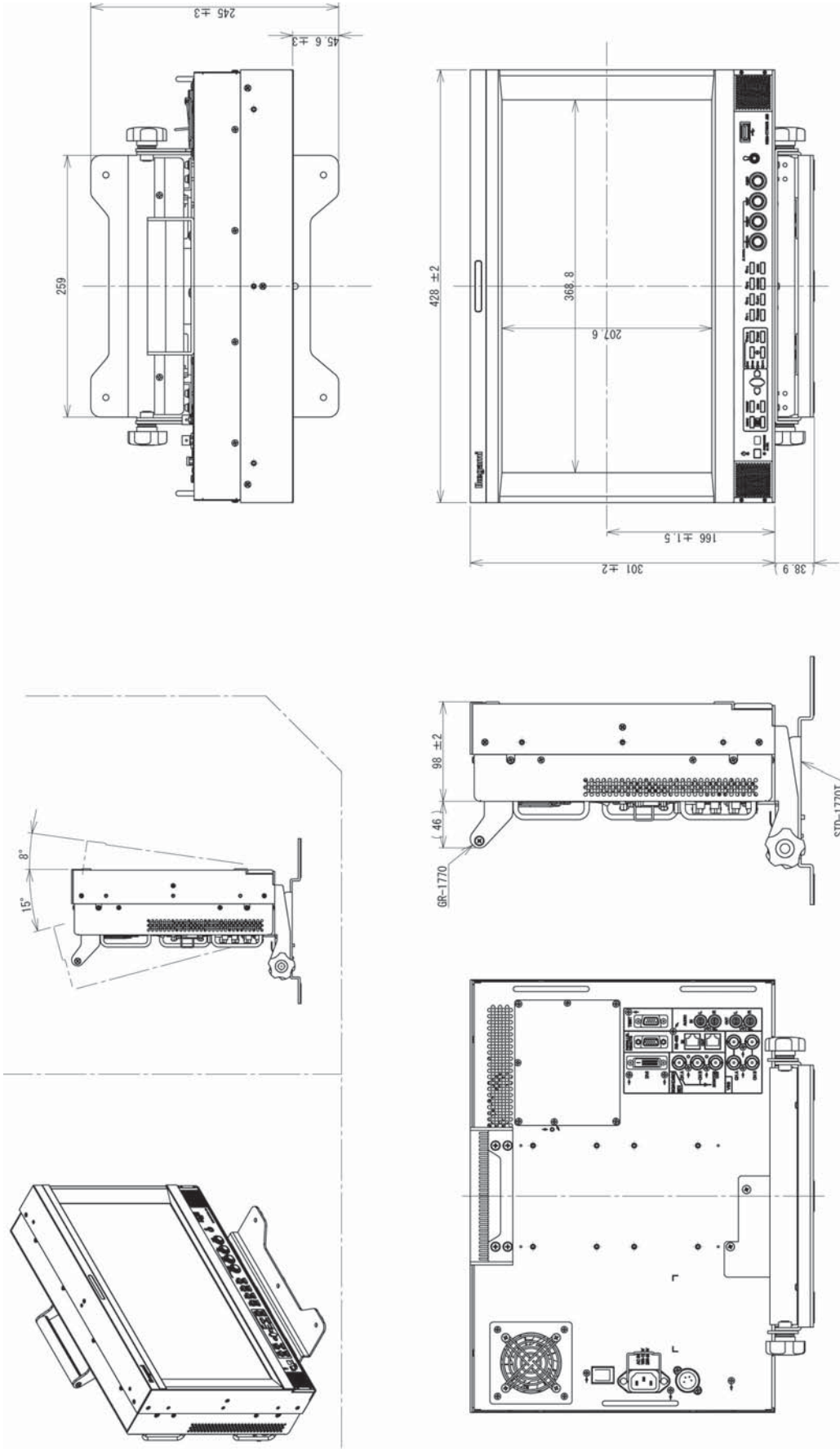

(3) HEM-2570W

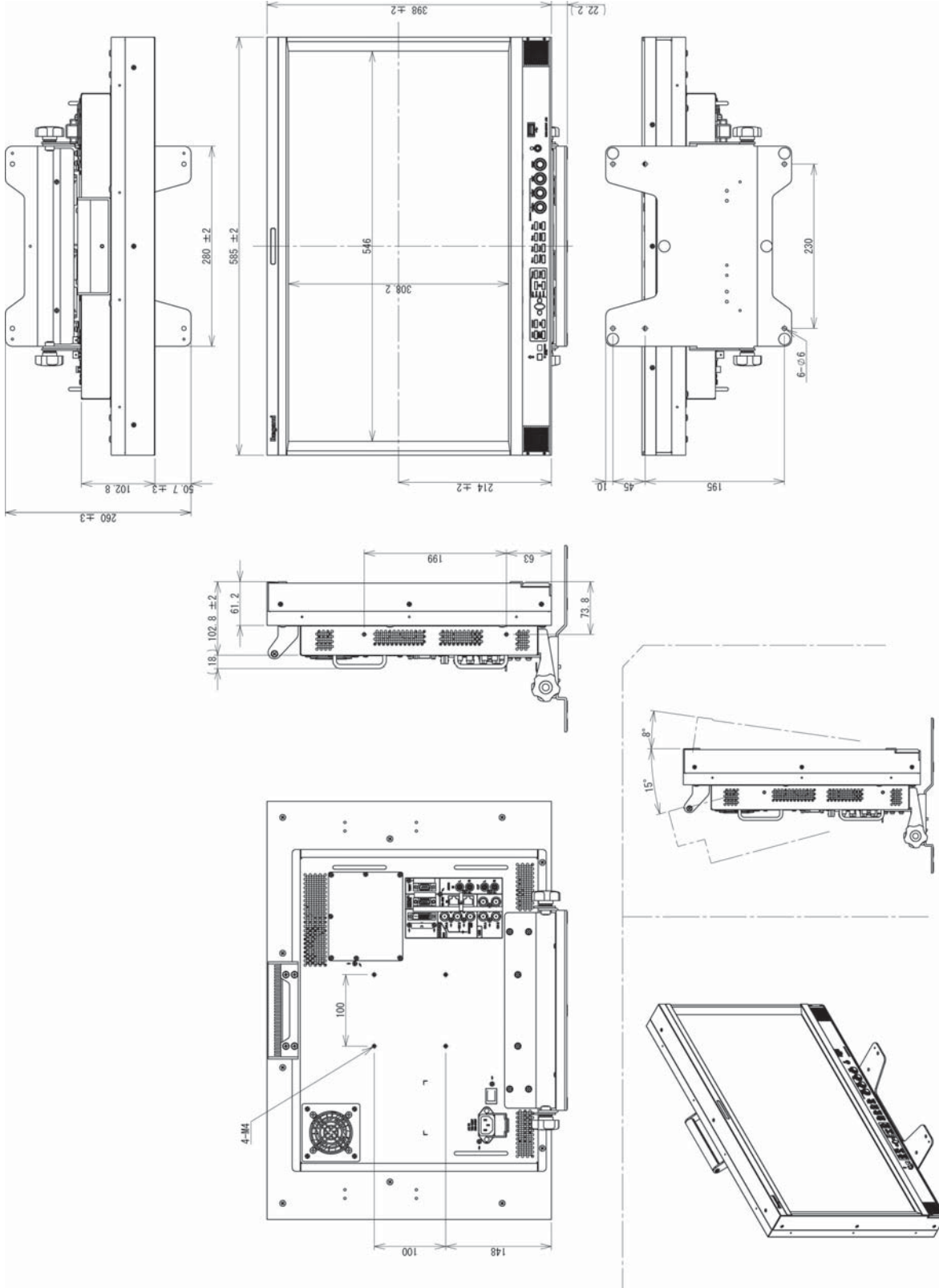

Data 1 PC Input Signal Compatible Format

| No. | Input signal | Horizontal frequency [kHz] | Vertical frequency [Hz] | Clock frequency [MHz] |
|-----|------------------|-------------------------------|----------------------------|--------------------------|
| 1 | VGA (640×480) | 31.48 | 59.95 | 25.18 |
| 2 | | 37.86 | 72.81 | 31.50 |
| 3 | | 37.50 | 75.00 | 31.50 |
| 4 | | 43.27 | 85.01 | 36.00 |
| 5 | SVGA (800×600) | 35.16 | 56.25 | 36.00 |
| 6 | | 37.88 | 60.32 | 40.00 |
| 7 | | 48.08 | 72.19 | 50.00 |
| 8 | | 46.88 | 75.00 | 49.50 |
| 9 | | 53.67 | 85.06 | 56.25 |
| 10 | XGA (1024×768) | 48.36 | 60.00 | 65.00 |
| 11 | | 56.48 | 70.07 | 75.00 |
| 12 | | 60.02 | 75.03 | 78.75 |
| 13 | | 68.68 | 85.00 | 94.50 |
| 14 | WXGA(1280×768) | 48.13 | 60.02 | 81.25 |
| 15 | SXGA(1280×1024) | 63.98 | 60.02 | 108.00 |
| 16 | UXGA(1600×1200) | 75.00 | 60.00 | 162.00 |
| 17 | WUXGA(1920×1200) | 73.46 | 60.61 | 157.50 |

Data 2 Parallel Remote Pin Function

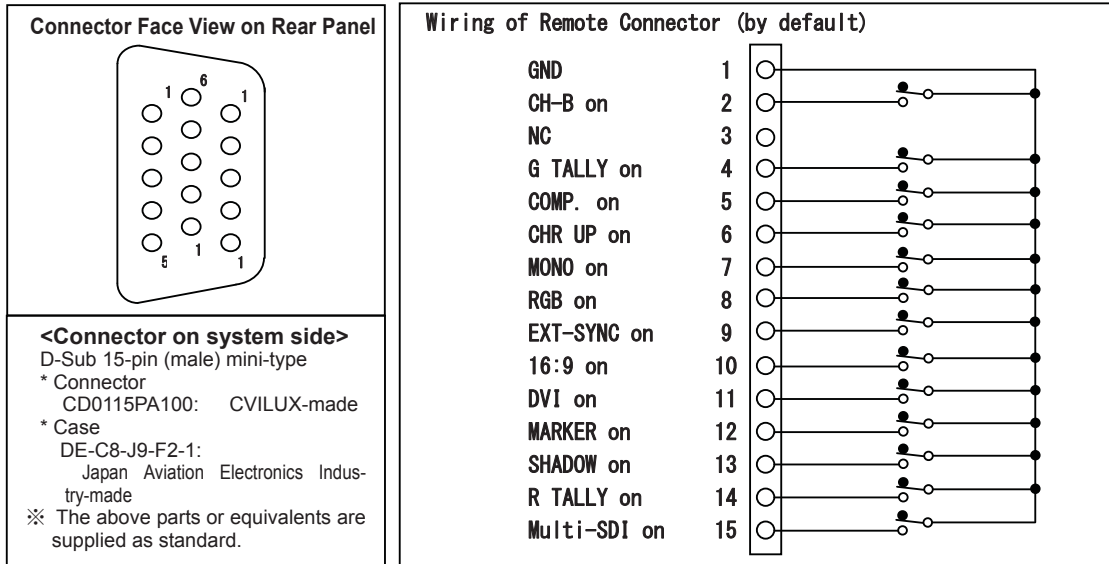

■ Pin functions by default

| Pin No. | Function | External Assignment for Function |
|---------|--------------|---|
| 1 | GND | Connecting remote terminals to this pin enables ON control. |
| 2 | CH-B on | Connect to Pin 1 to select B channel in the Multi-SDI input mode. * When Pin 2 is OPEN, the A channel will be selected. |
| 3 | NC | No connection |
| 4 | G TALLY on | Connect to Pin 1 to set G TALLY to ON. |
| 5 | COMP. on | Connect to Pin 1 to select the COMP. input with the CM-70 mounted. * When Pins 5, 11 and 15 are all open, the analog composite will be selected. |
| 6 | CHR UP on | Connect to Pin 1 to set CHROMA GAIN UP function to ON. |
| 7 | MONO on | Connect to Pin 1 to switch the COLOR/MONO setting to MONO. |
| 8 | RGB on | In COMP input selection, connect this pin to No.1 pin for switching the mode to RGB. |
| 9 | EXT-SYNC on | Connect to Pin 1 to switch the sync mode of the analog input to the external sync (EXT SYNC) with the CM-70 mounted. |
| 10 | 16:9 on | Connect to Pin 1 to change the aspect (4:3/16:9) of SDTV signals to 16:9. * If the setting is to be controlled simultaneously with channel switching, set [CHANGE ASPECT] to [MANUAL] in MENU 3-2 . |
| 11 | DVI on | Connect to Pin 1 to select the DVI input mode. * When Pins 5, 11 and 15 are all open, the analog composite will be selected. |
| 12 | MARKER on | Connect to Pin 1 to set MARKER to ON. |
| 13 | SHADOW on | Connect to Pin 1 to set SHADOW to ON. * The shadow is displayed in the MENU8 -preset level. |
| 14 | R TALLY on | Connect to Pin 1 to set Red TALLY to ON. |
| 15 | Multi-SDI on | Connect to Pin 1 to select the Multi-SDI input module. Use together with Pin 2 to switch between channels A and B. * When Pins 5, 11, 15 are open, the analog composite will be selected. |

■ Additional user-set functions

| Pin No. | Function | External Assignment for Function |
|--------------|--------------|--|
| User setting | SHADOW0 on | Connect to Pin 1 for running with the shadow level 0% (black). * Priority is given to this pin function if any other shadow setting pin is pressed at once. |
| User setting | SHADOW20 on | Connect to Pin 1 for running with the shadow level 20%. |
| User setting | SHADOW40 on | Connect to Pin 1 for running with the shadow level 40%. |
| User setting | SHADOW60 on | Connect to Pin 1 for running with the shadow level 60%. |
| User setting | ANALOG PC on | Connect to Pin 1 for selecting the ANALOG PC input with CM-70 mounted. * When all the input select pins are open, the analog composite signal is selected. |

* The functions of pins other than 1 are freely user-settable on MENU.

Data 3 Control with Remote Controller

| Control item | Serial remote SRC-400 | Wireless remote RCT-20A/30A | Remarks |
|-----------------------------------|-----------------------|-----------------------------|---------------------------------|
| ■ Switch functions | | | |
| VIDEO SELECT | — | ○(※1) | |
| VIDEO A (VBS) | ○ | — | |
| VIDEO B (VBS) | ○ | — | |
| YPbPr/RGB | ○ | — | |
| SDI A | ○ | — | |
| SDI B | ○ | — | |
| DVI | ○ | — | |
| OPTION | ○ | — | |
| TEST | ○ | ○(※1) | |
| APERTURE ON/OFF | ○ | ○ | |
| COLOR/MONO | ○ | ○ | Ineffective in RGB/PC input |
| BLUE ONLY ON/OFF | ○ | ○ | |
| DELAY (H/V/PCR) | ○ | ○ | Ineffective in VBS/PC input |
| 4:3/16:9 SCAN SELECT | ○ | ○ | Ineffective in HDTV input |
| NORMAL/UNDER SCAN | ○ | | |
| SYNC INT/EXT | — | ○ | Ineffective in VBS/SDI/PC input |
| FILE SELECT | ○(※2、※3) | ○ | |
| MARKER ON/OFF | ○ | ○ | |
| FUNCTION1-4 ON/OFF | ○ | — | |
| MENU/ENT/ESC | ○ | ○ | |
| ■ Variable preset level functions | | | |
| HUE | ○(※2) | ○(※2) | |
| CHROMA | ○(※2) | ○(※2) | |
| BRIGHTNESS | ○(※2) | ○(※2) | |
| CONTRAST | ○(※2) | ○(※2) | |
| APERTURE LEVEL | ○(※2) | ○(※2) | |
| R/G/B GAIN | ○(※2) | ○(※2) | |
| R/G/B BACKGROUND | ○(※2) | ○(※2) | |
| GAMMA RASTER | ○(※2) | ○(※2) | |

※1 : The switch toggles the modes as follows.

"SDI-A" → "SDI-B" → "VBS-A" → "VBS-B" → "DVI" → "Input selection when option is mounted"
→ "SDI-A" → ...

To give the TEST signal, hold down the VIDEO switch for about 3 seconds.

※2 : Adjustments through MENU operation.

※3 : Operation with the FUNCTION switch

Data 4 RS-485 Pin Function

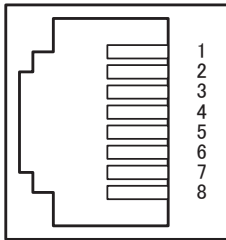

< Female terminal >

| Pin No. | IN terminal | OUT terminal |
|---------|-------------|--------------|
| 1 | TXD+ | TXD+ |
| 2 | TXD- | TXD- |
| 3 | RXD+ | RXD+ |
| 4 | GND | GND |
| 5 | GND | GND |
| 6 | RXD- | RXD- |
| 7 | NC | NC |
| 8 | NC | NC |

MODELS HEM-1770WR/2570W

**FULL HD MULTI FORMAT
OLED COLOR MONITOR**

OPERATION MANUAL

Published by Ikegami Tsushinki Co., Ltd.

© May. 2014 by Utsunomiya Factory
of Ikegami Tsushinki Co., Ltd.

All right reserved. Reproduction or duplication, without permission of Ikegami Tsushinki Co., Ltd. of edition or contents in whole in part, any manner, is prohibited. Specifications and design are subject to change without notice.

Ikegami

Ikegami Tsushinki Co., Ltd.

5-6-16, Ikegami, Ohta-ku, Tokyo, 146-8567, Japan
Phone: +81-(0)3-5700-4114 Fax: +81-(0)3-5748-2200
E-mail: info_e@ikegami.co.jp
URL: <http://www.ikegami.co.jp/en/>

Ikegami Electronics (U.S.A.), Inc.

37 Brook Avenue, Maywood, New Jersey 07607, U.S.A.
Phone: +1-201-368-9171 Fax: +1-201-569-1626
E-mail: engineering@ikegami.com, service@ikegami.com
URL: <http://www.ikegami.com>

Ikegami Electronics (Europe) GmbH

Ikegami Strasse 1, D-41460 Neuss, GERMANY
Phone: +49-(0)2131-123-0 Fax: +49-(0)2131-102820
E-mail: info@ikegami.de
URL: <http://www.ikegami.de>

Ikegami Electronics (Europe) GmbH-UK

Unit E1, Cologne Court, Brooklands Close,
Sunbury-on-Thames, Middlesex, TW16 7EB, UK.
Phone: +44-(0)1932-76 97 00 Fax: +49-(0)1932-76 97 10
E-mail: technical@ikegami.co.uk, sales@ikegami.co.uk

Property of