

Ikegami

INSTRUCTION MANUAL

21.5 INCH LED SDI MONITOR

Model **ULE-217A**
Rev.1



Please read this manual thoroughly before use, and keep it handy for future reference.

CONTENTS

SAFETY INSTRUCTION	2 ~ 3
CAUTIONS	4
FCC RF INTERFERENCE STATEMENT	5
CHECKING CONTROL BUTTONS/NAMES & FUNCTIONS OF I/O PORTS	6
REMOTE FUNCTIONS	7
MENU TREE & CONTROL	8
TO GET STARTED	9
MENU CONTROLS AND FUNCTIONS	10 ~ 16
SPECIFICATION	17 ~ 18
DIMENSION	19
TROUBLESHOOTING GUIDE	20

This Monitor was
Manufactured by ISO 9001
Certified Factory

SAFETY INSTRUCTION

Important Safety Instruction

1. Read these instructions.
2. Keep these Instructions.
3. Heed all warnings.
4. Follow all instructions.
5. Do not use this apparatus near water.
6. Clean only with dry cloth.
7. Do not block any ventilation openings. Install in accordance with the manufacturer's Instructions.
8. Do not install near any heat sources such as radiators, heat registers, stoves, or other apparatus (including amplifiers) that produce heat.
9. Do not defeat the safety purpose of the polarized or grounding-type plug.
A polarized plug has two blades with one wider than the other.
A grounding type plug has two blades and a third grounding prong.
The wide blade or the third prong are provided for your safety
If the provided plug does not fit into your outlet, consult an electrician for replacement of the obsolete outlet
10. Protect the power cord from being walked on or pinched particularly at plugs, convenience receptacles and the point where they exit from the apparatus
11. Only use attachment/accessories specified by the manufacturer.
12. Use only with the cart, stand, tripod, bracket or table specified by the manufacturer or sold with the apparatus. When a cart is used, use caution when moving the cart/apparatus combination to avoid injury from tip-over.
13. Unplug this apparatus during lightning storms or when unused for long periods of time.
14. Refer all servicing to qualified service personnel. Servicing is required when the apparatus has been damaged in any way, such as power-supply cord or plug is damaged, liquid has been spilled or objects have fallen into the apparatus the apparatus has been exposed to rain or moisture does not operate normally or has been dropped.



SAFETY INSTRUCTION

- The apparatus shall not be exposed to dripping or splashing and that no objects filled with liquids, such as vases, shall be placed on the apparatus
- 14 Minimum distances(e.g. 10cm) around the apparatus for sufficient ventilation.

“WARNING – To reduce the risk of fire or electric shock, do not expose the apparatus to rain or moisture.”

“The apparatus shall not be exposed to dripping or splashing and no objects filled with liquids, such as vases, shall be placed on the apparatus.”

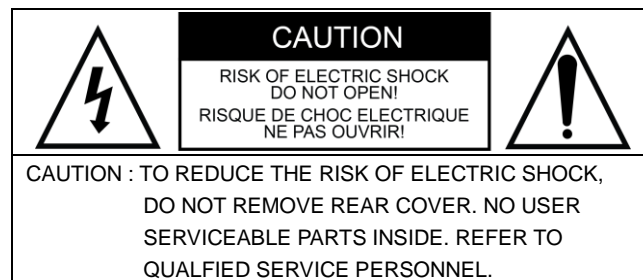

The lightning flash with arrowhead symbol, within an equilateral triangle, is intended to alert the user to the presence of “dangerous voltage” within the product’s enclosure that may be of sufficient magnitude to constitute a risk of electric shock to persons.



The exclamation point within an equilateral triangle is intended to alert the user to the Presence of important operating and maintenance (servicing) instructions in the literature Accompanying the product.

CAUTIONS

CAUTION

The power supply cord is used as the main disconnect device, ensure that the socket-outlet is located/installed near the equipment and is easily accessible.

ATTENTION

Le cordon d'alimentation est utilisé comme interrupteur général. La prise de courant doit être située ou installée à proximité du matériel et être facile d'accès

CAUTION TO SERVICE PERSONNEL

POWER SUPPLY CORD IS USED AS MAIN POWER DISCONNECT DEVICE IN THIS PRODUCT. UNPLUG THIS PRODUCT FROM THE WALL OUTLET BEFORE REMOVING THE BACK COVER AND SERVICING

EMISSION CHARACTERISTICS TESTED BY SEMKO

THIS PRODUCT HAS BEEN TESTED AND HAS SHOWN COMPLIANCE WITH THE NATIONAL SPECIFICATIONS SUCH AS SWEDISH MPR 1990.10.(MPR II)

▶ NEVER REMOVE THE BACK COVER

Removal of the back cover should be carried out only by qualified personnel.

▶ DO NOT USE IN HOSTILE ENVIRONMENTS

To prevent shock or fire hazard, do not expose the unit to rain or moisture.

This unit is designed to be used in the office or home. Do not subject the unit to vibrations, dust or corrosive gases.

▶ KEEP IN A WELL VENTILATED PLACE

Ventilation holes are provided on the cabinet to prevent the temperature from rising.

Do not cover the unit or place anything on the top of unit.

▶ AVOID HEAT

Avoid placing the unit in direct sunshine or near a heating appliance.

▶ TO ELIMINATE EYE FATIGUE

Do not use the unit against a bright background and where sunlight or other light sources will shine directly on the monitor.

▶ BE CAREFUL OF HEAVY OBJECT

Neither the monitor itself nor any other heavy object should rest on the power cord.

Damage to a power cord can cause fire or electrical shock.

FCC RF INTERFERENCE STATEMENT

NOTE

This equipment has been tested and found to comply with the limits for a Class A digital device, pursuant to Part 15 of the FCC Rules. These limits are designed to provide reasonable protection against harmful interference in a residential installation.

This equipment generates, uses and can radiate radio frequency energy and, if not installed and used in accordance with the instructions, may cause harmful interference to radio communications. However, there is no guarantee that interference will not occur in a particular installation.

If this equipment does cause harmful interference to radio or television reception which can be determined by turning the equipment off and on, the user is encouraged to try to correct the interference by one or more of the following measures.

- Reorient or relocate the receiving antenna.
- Increase the separation between the equipment and receiver.
- Connect the equipment into an outlet on a circuit different from that to which the receiver is connected.
- Consult the dealer or an experienced radio, TV technician for help.
- Only shielded interface cable should be used.

Finally, any changes or modifications to the equipment by the user not expressly approved by the grantee or manufacturer could void the users authority to operate such equipment.

► DOC COMPLIANCE NOTICE

This digital apparatus does not exceed the Class A limits for radio noise emissions from digital apparatus set out in the radio interference regulation of Canadian Department of communications.

CHECKING CONTROL BUTTONS / NAMES & FUNCTIONS OF I/O PORTS

1. Checking Control Buttons

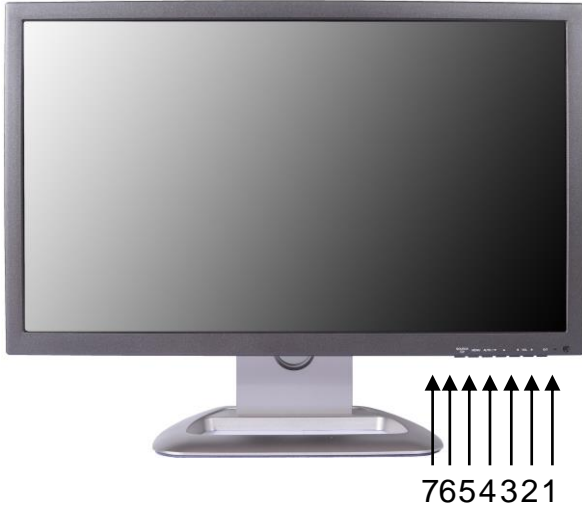

1. Power
2. Auto
3. Enter
4. Up
5. Down
6. Menu
7. Source

2. Names and Functions of I/O Ports

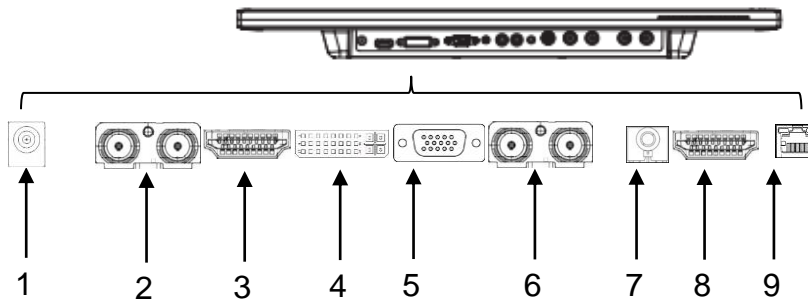

1. DC 12V In
2. SDI In / SDI Out
3. HDMI In
4. DVI
5. VGA
6. CVBS In / Out
7. Audio In
8. PGM
9. RS422 In

REMOTE FUNCTIONS

Remote Controller(Optional)

1. POWER(🔌)

Turns the power ON or OFF. There will be a few seconds delay before the display appears.

2. SOURCE

Selects an input source.

3. AUTO

Auto geometry adjustment in the RGB-PC source.

4. HOLD

Unavailable

5. MUTE

Mutes the sound.

6. MENU

Activates and exits the On Screen Display.

7. EXIT

Exits the On Screen Display.

8. VOL(◀ & ▶)

Increases or decreases the level of audio volume.

9. UP/DOWN

Moves upwards or downwards in the OSD menu.

10. ENTER

Enters an OSD submenu or accepts your selection.

11. INFO

Displays the information about input source.

12. STILL

Unavailable

13. PIP (Picture In Picture)

Unavailable

14. P.INPUT

Unavailable

15. P.POS

Unavailable

16. P.SIZE

Unavailable

17. SWAP

Unavailable

18. ARC (Aspect Ratio Control)

Unavailable

19. APC (Auto Picture Control)

Unavailable

20. ACC (Auto Color Control)

Unavailable

21. S.SET

Unavailable

22. PC

Unavailable

23. AV

Unavailable

24. COMP

Unavailable



MENU TREE & CONTROL

1. Menu Tree

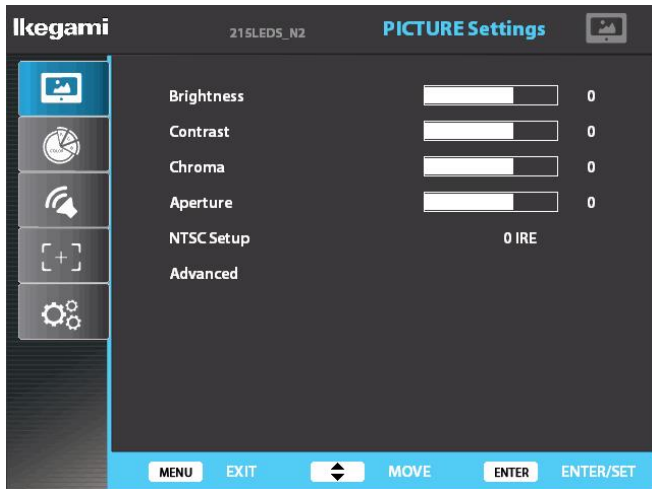

Main menu includes

- 1) Picture Settings
- 2) Color Settings
- 3) Audio Settings
- 4) Marker Setting
- 5) System Settings

The picture above shows Picture Settings menus in ULE-217A monitor.

2. Menu Control

Menu control can be handled by front keys

- 1) Menu
- 2) Up
- 3) Down
- 4) Enter

- Press Menu button to enter menu
- Use Up / Down keys on front to choose desired menu
- To enter desired menu press Enter key
- To exit to the previous step press Menu button
- Menu turns to blue when selected
- Grey menus are not yet activated

TO GET STARTED

To get ULE-217A monitor started, connect required power and choice of your input signal. Turn on the power button on the front.

1) To choose the input signal after cable connection, please use Source button on front.

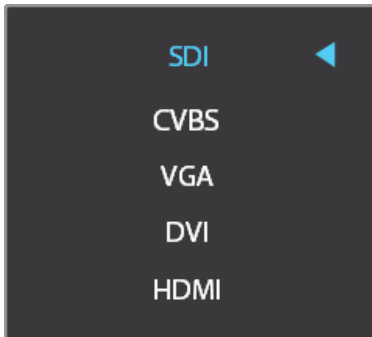

- Use either up and down keys to move to your input. Then, press enter to select.

- Blue arrow shows your choice and when selected the menu turns to blue

2) If there's no input for your selected source, the window will show No sync/signal.



MENU CONTROLS AND FUNCTIONS

1. Picture Settings

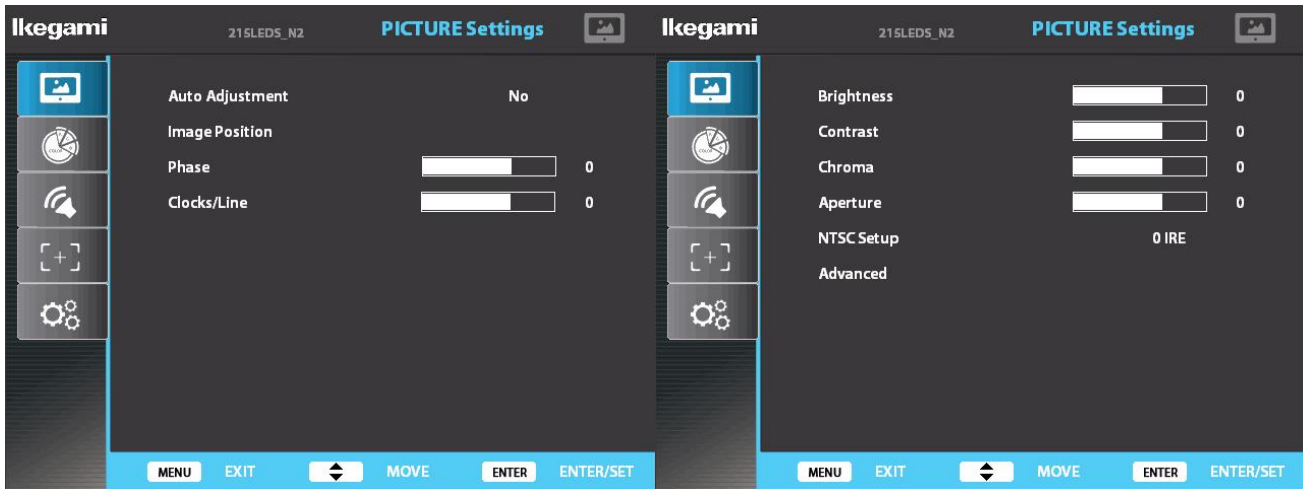

■ Brightness

- used to control brightness(offset) level from 0 to 100
- shown in grey as it can be controlled by front knobs without entering the menu

■ Contrast

- used to control contrast(gain) level from 0 to 100
- shown in grey as it can be controlled by front knobs without entering the menu

■ Chroma

- used to control chroma(saturation) level from 0 to 100
- shown in grey as it can be controlled by front knobs without entering the menu

■ Aperture

- used to control sharpness level from 0 to 24 (0 for smooth and 24 for edge)
- ULE-217A recommend to use internal pattern edge for easier selection

■ NTSC Setup

- used to control the difference black level when NTSCJ for Japan is used
- used for component signal only

■ Advanced

- used for VGA input only

1) Auto Adjustment

- used to turn on and off automatic position of VGA input by controlling phase and clocks/line
- it can be controlled using Auto key on front

2) Image Position

- used to move the position manually for VGA input

MENU CONTROLS AND FUNCTIONS

2. Color Settings

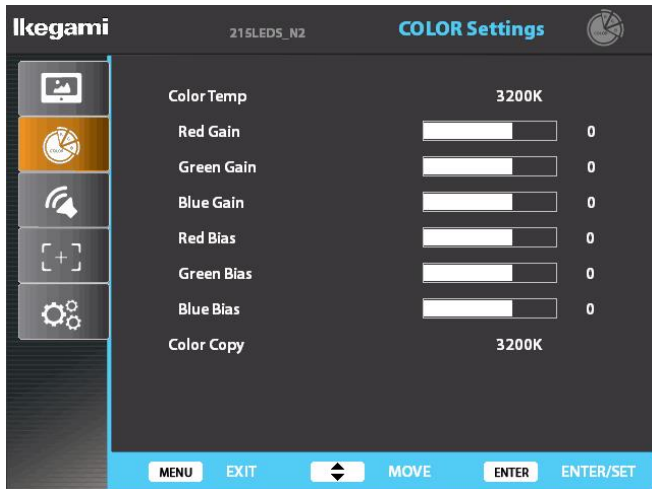

■ Color Temp

- used to control color temperature
- users can choose 3200K, 6500K, 9300K, User 1, User 2, and User 3
- in user # mode, users can define RGB Gain and Bias values for own purpose

■ Gain Red/Green/Blue

- changes only in user # mode
- used to set R/G/B Gain level from -128 to 128

■ Bias Red/Green/Blue

- changes only in user # mode
- used to set R/G/B Bias level from -50 to 50

■ Color Copy

- used to set standard for user # mode
- select color copy and choose among 3200K, 6500K, or 9300K, then preset values will be shown in RGB Gain and Bias. Users can define their own values based on these preset values.

MENU CONTROLS AND FUNCTIONS

3. Audio Settings

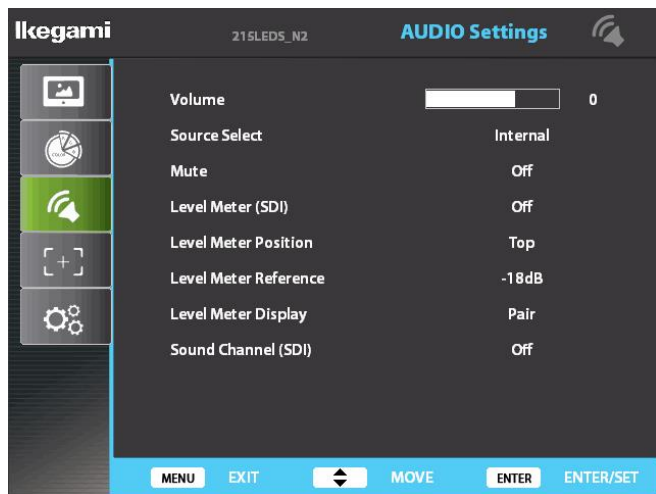

■ Volume

- used to control volume level of the internal speaker on the back of the monitor from 0 to 100
- shown in grey as it can be controlled by front knobs without entering the menu

■ Source Select

- used to select between Internal and External source of audio
- when an external source is connected to audio in, select External

■ Mute

- used to turn off entire audio volume for all sources both internal and external
- to turn back on the audio volume to previous level select OFF

■ Level Meter (SDI)

- used to set the level meter for embedded audio only available in SDI input
- users can choose Off, 16 CH Horizontal, and 16 CH Vertical
- 16 CH Horizontal shows 8 channels in each side horizontally
- 16 CH Vertical shows 8 channels in each side vertically

■ Level Meter Position

- used to select audio level meter position on screen depending on user's display
- users can choose Top, Middle, and Bottom for both horizontal and vertical

■ Level Meter Reference

- used to select between -18dB and -20dB depending on user's source
- when -20dB is selected, yellow area expands to next marking. Audio level meter within selected value turns to green and exceeded audio level is displayed in yellow

■ Level Meter Display

- used to set the display method for audio level meter between Group and Pair.
- Pair represents level meter in even and odd, and Group shows first 8 channels on left and next 8 channels on right

MENU CONTROLS AND FUNCTIONS

3. Audio Settings (Continued)

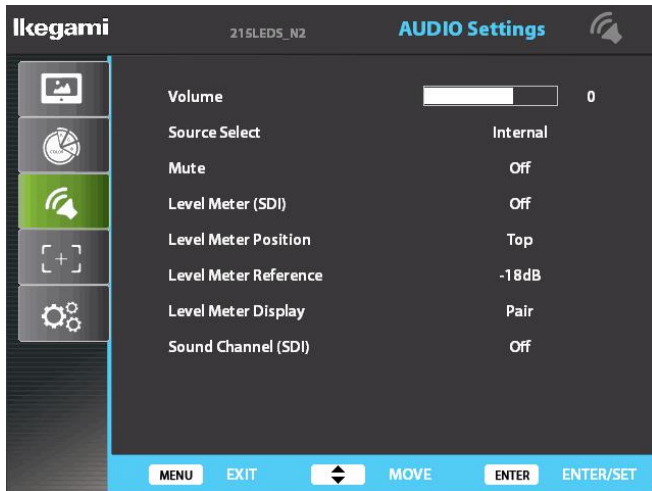

■ Sound Channel (SDI)

- used to set embedded audio channel for internal speaker or Audio Out
- select from CH1, CH2, CH1+CH2, CH3, CH4, CH3+CH4, CH5, CH6, CH5+CH6, CH7, CH8, CH7+CH8, CH9, CH10, CH9+CH10, CH11, CH12, CH11+CH12, CH13, CH14, CH13+CH14, CH15, CH16, and CH15+CH16
- when CH1 is chosen, user can hear CH1 from both speakers. When CH1+CH2 is chosen, user can hear CH1 from left speaker and CH2 from right speaker

MENU CONTROLS AND FUNCTIONS

4. Marker Settings

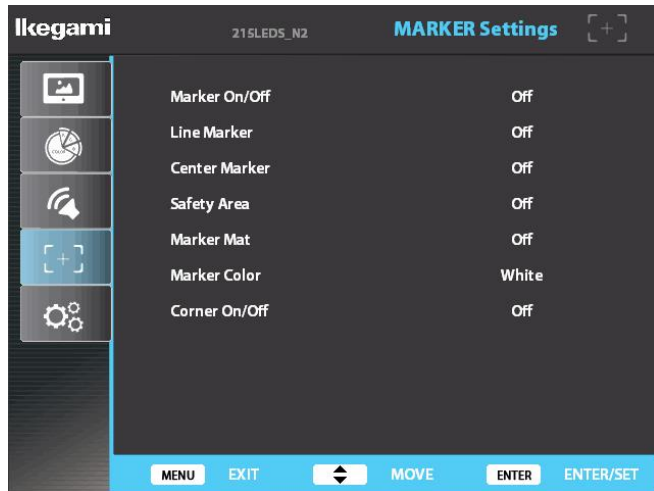

■ Marker On/Off

- used to activate the marker function
- Marker should be ON to use any features in Marker Setting menu

■ Line Marker

- used to select user's desired marker type
- available in off, 16:9, 4:3, 4:3(on air), 15:9, 14:9, 13:9, 1.85:1, 2.35:1, 1.85:1 and 4:3

■ Center Marker

- used to turn on and off center marker

■ Safety Area

- used to select safety area among off, 80%, 85%, 88%, 90%, 93% and 100%

■ Marker Mat

- used to change darkness of areas out of line marker
- select level from OFF (transparent) to 7 (black)

■ Marker Color

- used to change marker color on the screen
- select from blue, green, red, gray, black, and white

■ Corner On/Off

- used to show safety area by ticks rather than a box
- Safety area shown in regular line when the feature is off

MENU CONTROLS AND FUNCTIONS

5. System Settings

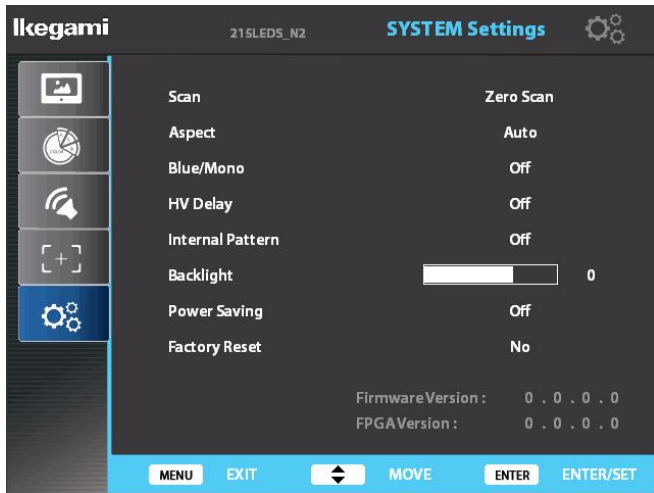

■ Scan

- used to change the scan mode among zero scan, over scan, and pixel to pixel
- when pixel to pixel is on, turn the main jog to move the position

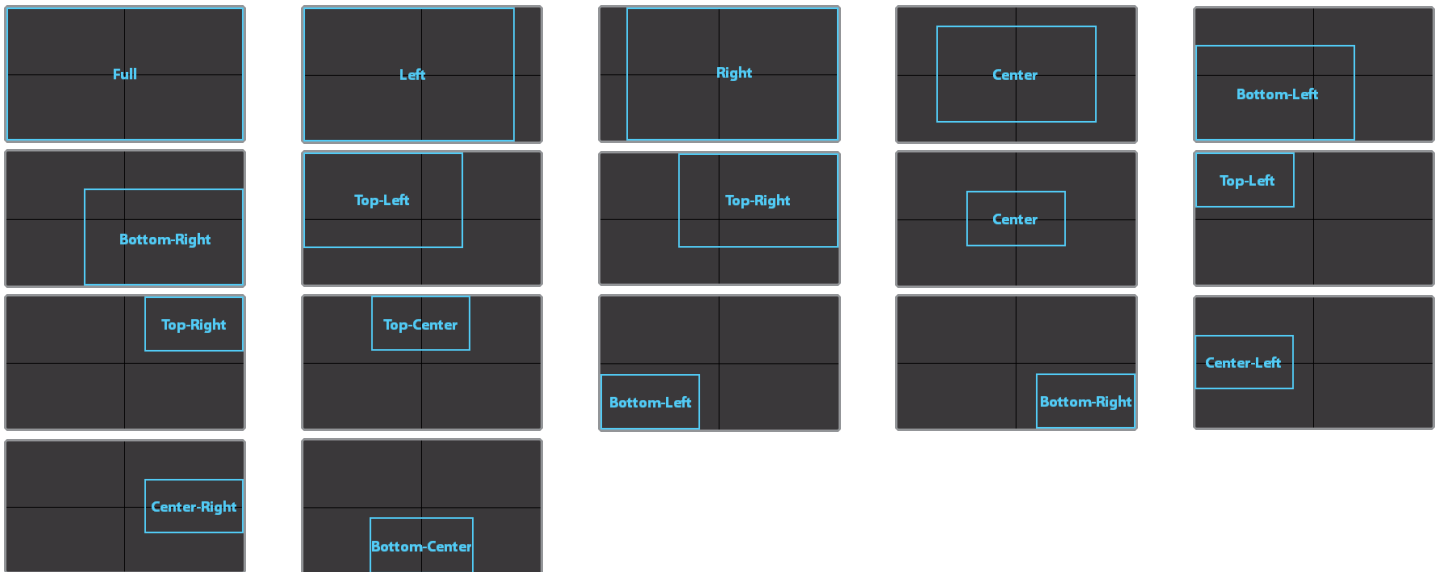

- **when system setting is in pixel to pixel, marker features don't work**

■ Aspect

- used to change the display ratio among full screen, 16:9, and 4:3

■ Blue/Mono

- used to change the display among off(regular), mono, and blue

■ H/V Delay

- used to observe blank area for H sync and V sync
- **when system setting is in H/V delay, marker features don't work**

■ Internal Pattern

- used to turn on internal pattern among off, color bar, and white

■ Backlight

- to control backlight of screen from 0 to 100

MENU CONTROLS AND FUNCTIONS

6. System Settings (Continued)

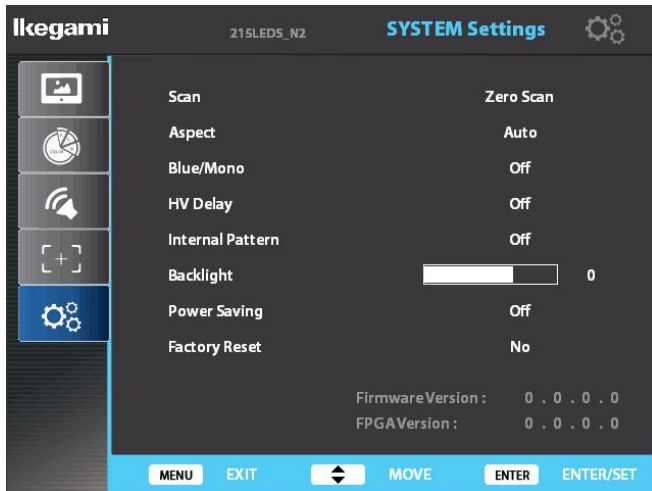

■ Power Saving

- select between off and DPMS
- when DPMS is selected and there's no input signal for longer than 15sec, monitor takes sleep mode
- LED light on front: red-power off, green-power on, orange blink-no input, orange-DPMS(sleep mode)

■ Factory Reset

- used to reset the monitor to factory default setting

SPECIFICATION

ULE-217A Rev.1			
Display			
Screen Size	21.5"		
Max Resolution	1920 X 1080		
Pixel Pitch	0.08265mm X 0.24795mm		
Brightness	250cd/m ² (Typical)		
Contrast Ratio	1000:1		
Aspect Ratio	16:9		
Viewing Angle (H/V)	170°/160°		
Color Depth	16.7M		
Input Connector			
1 x BNC	SDI (SD/HD/3G)		
1 x BNC	CVBS Input		
1 x HDMI	HDMI Input		
1 x DVI	DVI Input		
1 x VGA	VGA Input		
1 x Phone Jack	Analog Stereo Audio Input		
1 x RJ45 Jack	RS422 Monitor Control		
1 x HDMI	PGM Download Port		
Input Signal Format			
SDI	SMPTE 425M-A	YCbCr 4:2:2 10bit	1080P (60/59.94/50)
	SMPTE 274M	YCbCr 4:2:2 10bit	1080i (60/59.94/50)
			1080P (30/29.97/25/24/23.98)
			1080Psf (30/29.97/25/24/23.98)
	SMPTE 296M	YCbCr 4:2:2 10bit	720P(60/59.94/50/30/29.97/25/24/23.98)
	SMPTE 125M	YCbCr 4:2:2 10bit	525i (NTSC 59.94)
	ITU-R BT.601	YCbCr 4:2:2 10bit	625i (PAL 50)
2K Format	YCbCr 4:2:2 10bit	2048 x 1080P (24/23.98/24sF/23.98sF)	
ANALOG	CVBS		NTSC(525/59.94i) , PAL(625/50i)
HDMI			480i/480P/576i/576P/1080i/1080P
DVI			VGA, SGA, XGA, SXGA, WXGA, WUXGA
VGA			VGA, SGA, XGA, SXGA, WXGA, WUXGA

Dimensions	
Outline Dimension	20.27" x 15.35" x 1.96
(W x H x D)	(515mm x 390mm x 50mm)
Net Weight	3.2Kg
General	
Electrical Ratings	12V $\overline{=}$ 3.33A
Operating Temperature	0~40°C (32~104°F)

DIMENSION



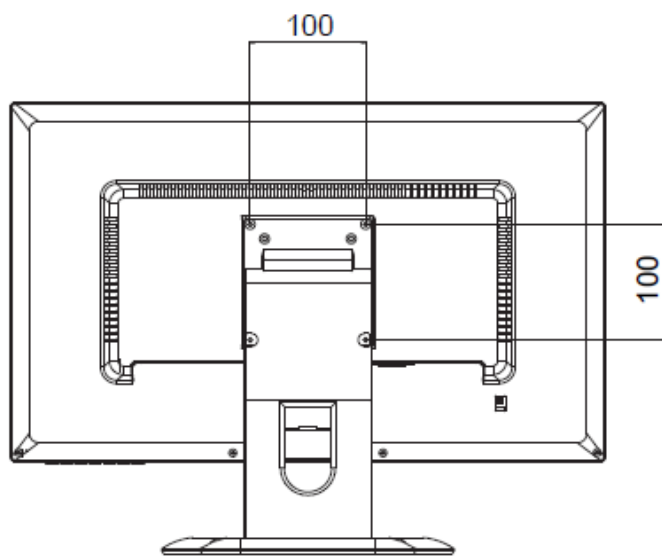
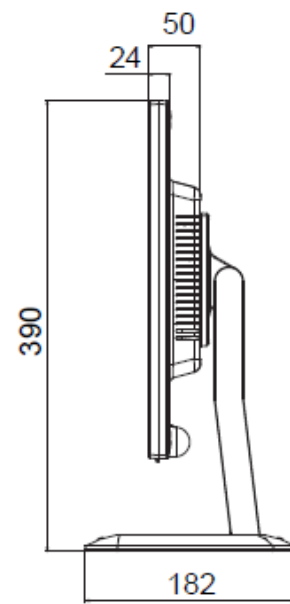
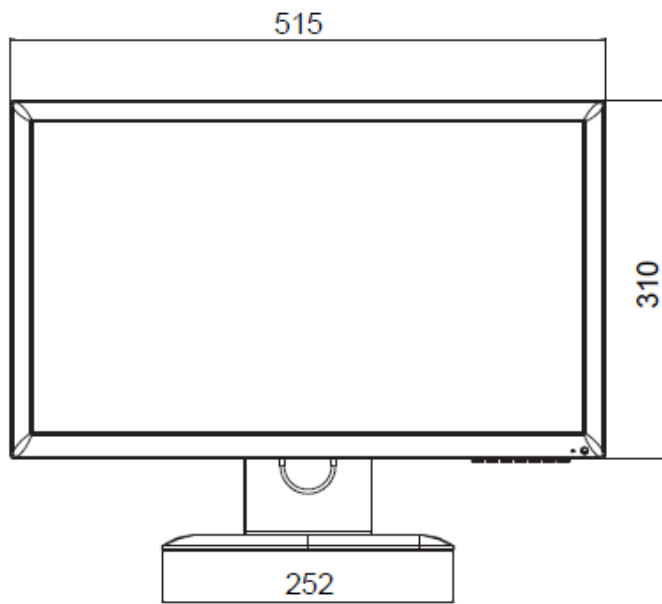

(Unit: mm)



TROUBLESHOOTING GUIDE

TROUBLE	TROUBLESHOOTING TIP
No image on display screen	<ol style="list-style-type: none"> 1. Check that power cord of the Monitor have been connected securely into wall outlet or grounded extension cable or strip. 2. Power switch should be in the ON position and LED is lit. 3. Check that the Brightness and/or the Contrast adjustments of the Display have not been turned down to minimum levels.
"NO SIGNAL" message on screen	<ol style="list-style-type: none"> 1. The signal cable should be completely connected to the video card/computer. 2. The video card should be completely seated in its slot and the computer is switched ON.
Display image is not centered, too small or too large in PC mode	Push the down key in front side or Auto key in remote controller.
Vertical or Horizontal noise is present in the picture	Adjust Clock and Phase in the OSD.

WEEE Symbols

	<p>This product's packaging materials are recyclable and can be reused. Please dispose Of any materials in accordance with the local recycling regulations. When discarding the unit, comply with local rules or regulations. Batteries should never be thrown away or incinerated but disposed of in Accordance with the local regulations concerning chemical waste. This product and the accessories packed together constitute the applicable Product according to the WEEE directive except battery.</p>
	<p>To indicate on the rating plate that the equipment is suitable for direct current only. To identify relevant terminals.</p>
	<p>To identify the switch or switch position by means of which Part of the equipment is switched on in order to bring it into The stand-by condition.</p>
	<p>The lightning flash with arrowhead symbol, within an equilateral triangle, is intended to alert the user to the presence of "dangerous voltage" within the product's enclosure that may be of sufficient magnitude to constitute a risk of electric shock to persons.</p>
	<p>The exclamation point within an equilateral triangle is intended to alert the user to the Presence of important operating and maintenance (servicing) instructions in the literature Accompanying the product.</p>

MEMO

Ikegami

Ikegami Tsushinki Co., Ltd.

5-6-16 Ikegami, Ohta-ku, Tokyo, Japan 146-8567

Phone:(03)5700-1111 Fax:(03)5700-1137

Ikegami Electronics (U.S.A), Inc.

300 Route 17 South, Mahwah, NJ 07430

Phone:(201)368-9171, Fax:(201)569-1626

Ikegami Electronics (Europe) GmbH

Ikegami Strasse 1, D-41460 Neuss, Germany

Phone:(02131)123-0, Fax:(02131)102820

Ikegami Electronics Asia Pacific Pte.Ltd.

1 Tampines Central 5 #03-03 CPF Tampines Building, Singapore 529508

Phone:+65 62 608 820, Fax:+65 62 608 896

Property of